

## AKI

Wall lamp for interiors, with body made of fully recyclable die-cast aluminum. The lamp includes a built-in cooler with an LED that guarantees performance, quality of light and long life. The light is diffused, developing both upwards and downwards.

## AKI

Lampada da parete per interni, con corpo realizzato in alluminio pressofuso interamente riciclabile. È una lampada con dissipatore integrato sul quale è alloggiato un LED che garantisce prestazioni, qualità della luce e lunga durata. La luce è diffusa, sviluppandosi sia verso l'alto che verso il basso.

## AKI

Wandleuchte für Innenräume, mit Korpus aus Aluminiumdruckguss, vollständig recycelbar. Es handelt sich um eine Leuchte mit integriertem Kühlkörper, auf dem eine LED angebracht ist, die Leistung, Lichtqualität und lange Lebensdauer garantiert. Das diffuse Licht strahlt sowohl nach oben als auch nach unten.

## AKI

Lámpara de pared para interiores, con cuerpo de aluminio fundido a presión totalmente reciclable. Se trata de una lámpara con un dissipador de calor integrado en el que se aloja un LED que garantiza rendimiento, calidad de la luz y larga duración. La luz es difusa y va tanto hacia arriba como hacia abajo.

## AKI

Настенный светильник для внутреннего освещения с корпусом из алюминия, отлитого под давлением. Материал пригоден для вторичного использования. Это светильник со встроенным рассеивателем, на котором размещен светодиод, обеспечивающий хорошие рабочие характеристики, качество света и долгий срок службы. Свет рассеивается как вверх, так и вниз.



# AKI APPLIQUE

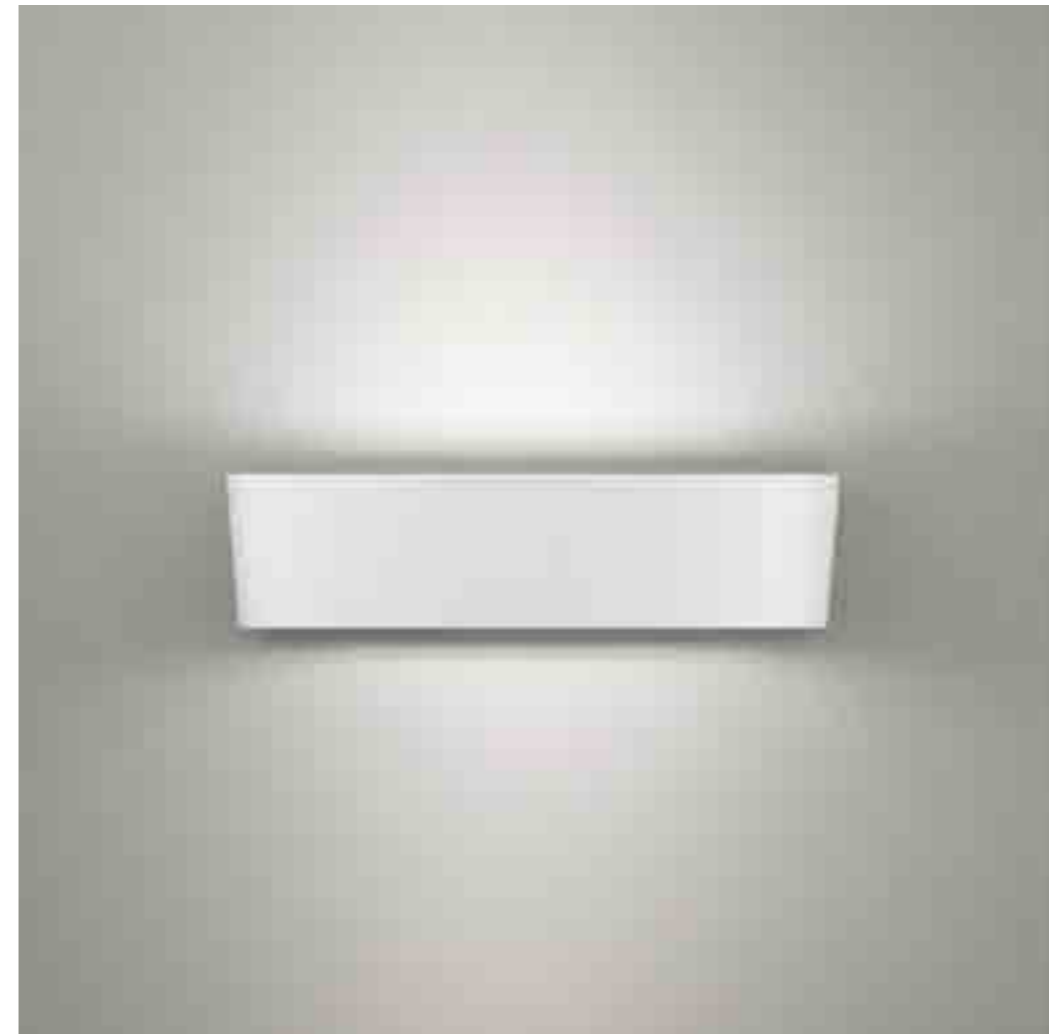



# AKI APPLIQUE





AKI APPLIQUE





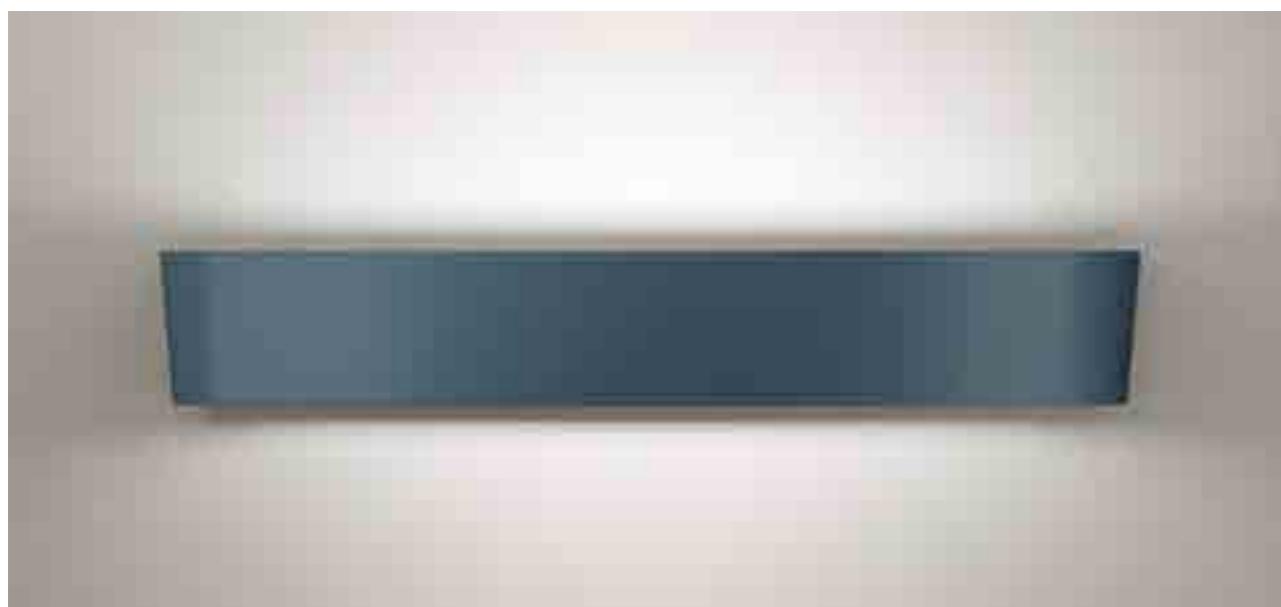





AKI APPLIQUE



# AKI APPLIQUE

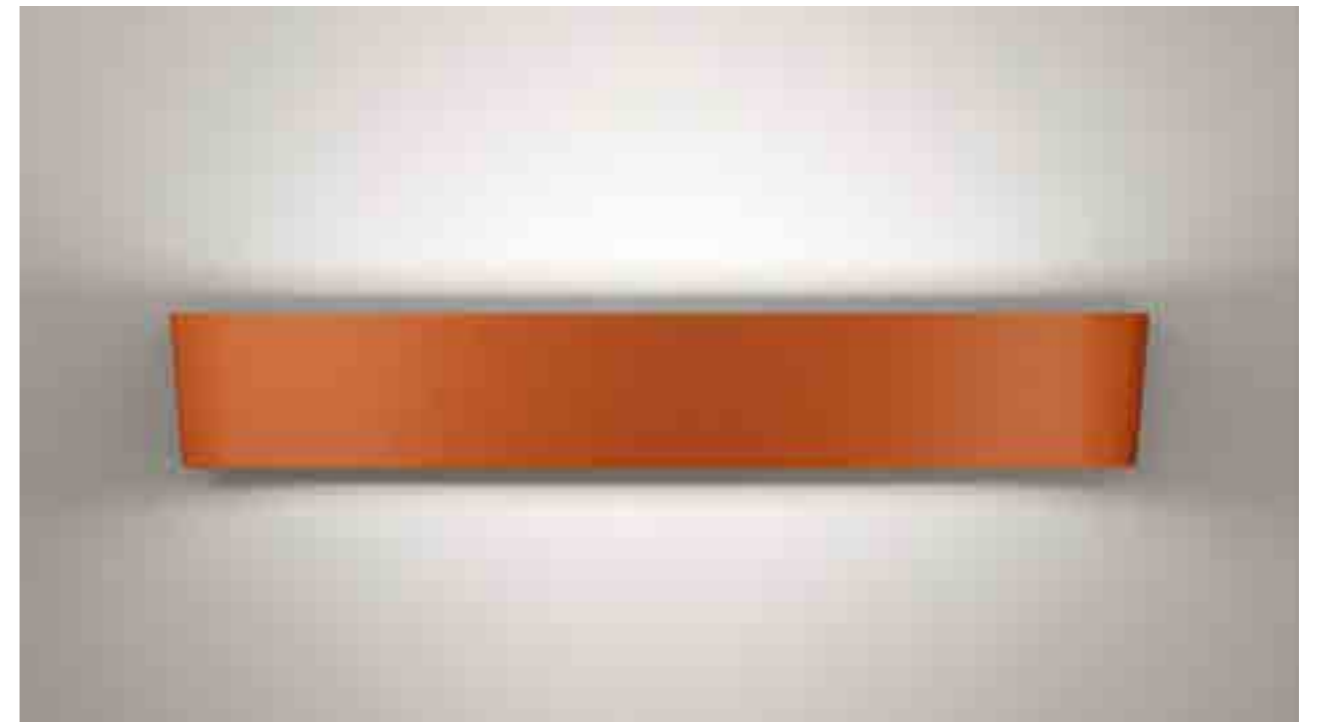



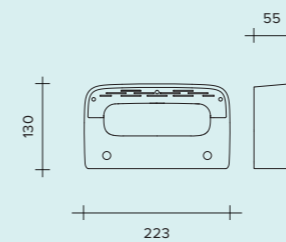

LED 11W  
 2700°K / 1567 lumen  
 3000°K / 1650 lumen  
 4000°K / 1733 lumen  
 CRI 90

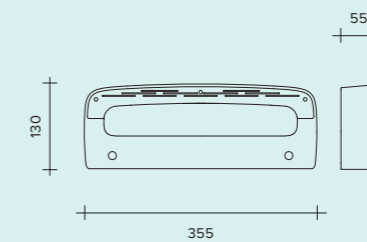

LED 22W  
 2700°K / 3054 lumen  
 3000°K / 3215 lumen  
 4000°K / 3375 lumen  
 CRI 90

## AKI Applique

Lampada da parete  
 Wandleuchte  
 Lámpara de pared  
 Настенная лампа



### FINISHES / FINITURE / FARBE / ACABADOS / ОТДЕЛКИ

- White / Bianco / Weiß / Blanco / Белый цвет
- Sand / Sabbia / Sandfarben / Arena / Песочный цвет
- Brown / Moro / Braun / Marrón oscuro / Тёмно-коричневый цвет
- Petrol Blue / Blu ottanio / Oktanblau / Azul verdoso / Сине-зеленый
- Brick brown / Mattone / Ziegelstein / Ladrillo / Кирпичный цвет

## OLO

The Olo wall light features clean geometric shapes and well defined lines.

Designed to enhance environments, whether on or off, it is not intrusive and adapts easily to any interior space.

The rapid section changes and play of solids and voids give it a lightweight look, allowing light to pass through and wash the wall in a uniform manner.

The solid aluminium body, designed as a single piece, is die cast and available in powder-coated matt black or white finish or in a brushed finish in gold, copper, bronze or black nickel colours.

## WINNER



## OLO

*Olo è una lampada da parete dalle geometrie pulite e dalle linee definite.*

*Disegnata per caratterizzare gli ambienti, tanto da accesa quanto da spenta, non risulta mai intrusiva e si adatta facilmente a qualsiasi interno.*

*I rapidi cambi di sezione ed i giochi di pieni e vuoti contribuiscono a rendere leggera la sua estetica lasciando passare la luce e permettendole di lavare uniformemente la parete.*

*Il solido corpo in alluminio, studiato in un unico pezzo, è realizzato in pressofusione ed è disponibile verniciato in bianco o nero opaco, oppure in finitura spazzolata nei colori: oro, rame, bronzo o nichel nero.*

## OLO

*Olo ist eine Wandleuchte von sauberer Geometrie und mit definierten Linien.*

*Ihr Design wurde so gewählt, dass sie in ihrem Ambiente immer eine gute Figur macht, egal ob sie nun an oder aus ist; sie wirkt nie aufdringlich und passt sich jeder Umgebung an.*

*Die raschen Abschnittwechsel und die Spiele aus Voll und Leer tragen dazu bei, dass sie leicht erscheint; das Licht strahlt hindurch und erhellt gleichmäßig die Wand. Der solide Korpus wird in einem Stück aus druckgegossenem Aluminium angefertigt und ist in mattweiß oder mattschwarz lackiert erhältlich oder mit einem gebürsteten Oberflächenfinish in den Farben: Gold, Kupfer, Bronze oder Nickel schwarz.*

## OLO

*Olo es un aplique de pared con unas geometrías resueltas y líneas definidas.*

*Diseñada para caracterizar los ambientes, tanto cuando está encendida como cuando está apagada, nunca es intrusiva y se adapta fácilmente a cualquier interior.*

*Los rápidos cambios de sección y las combinaciones de llenos y vacíos contribuyen a hacer ligero su aspecto, dejando pasar la luz y permitiéndole iluminar uniformemente la pared. El cuerpo sólido de aluminio, estudiado en una sola pieza, lo realizamos mediante vaciado a presión y está pintado en los colores blanco o negro mate o bien con acabado cepillado en los colores: oro, cobre, bronce o níquel negro.*

## OLO

*Olo – это настенный светильник чистой геометрической формы и с четко выраженным дизайном.*

*Спроектированный, чтобы охарактеризовать любые интерьеры, как в включённом, так и в выключенном режиме, он никогда не является неуместным и легко подходит к любому интерьеру.*

*Быстрое изменение ширины сечения и игра полных и пустых объемов способствуют созданию чувства лёгкости его внешнего вида, пропускают свет и позволяют равномерно осветить стену 'омывающим' светом. Прочный монолитный алюминиевый корпус изготовлен путём литья под давлением и может быть окрашенным в белый или чёрный матовый цвет или с крацованной отделкой в цветах: золото, медь, бронза или чёрный никель.*

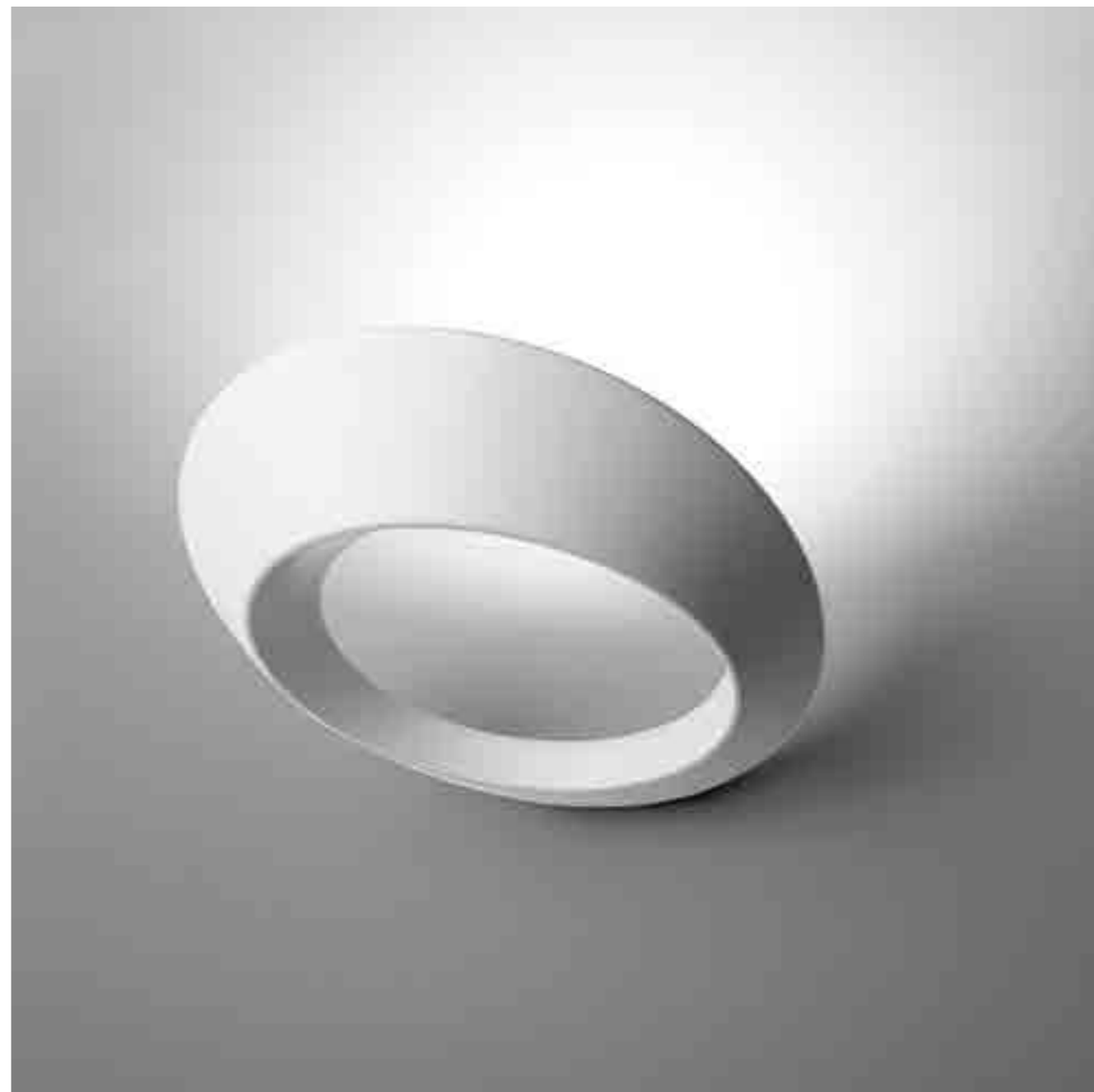

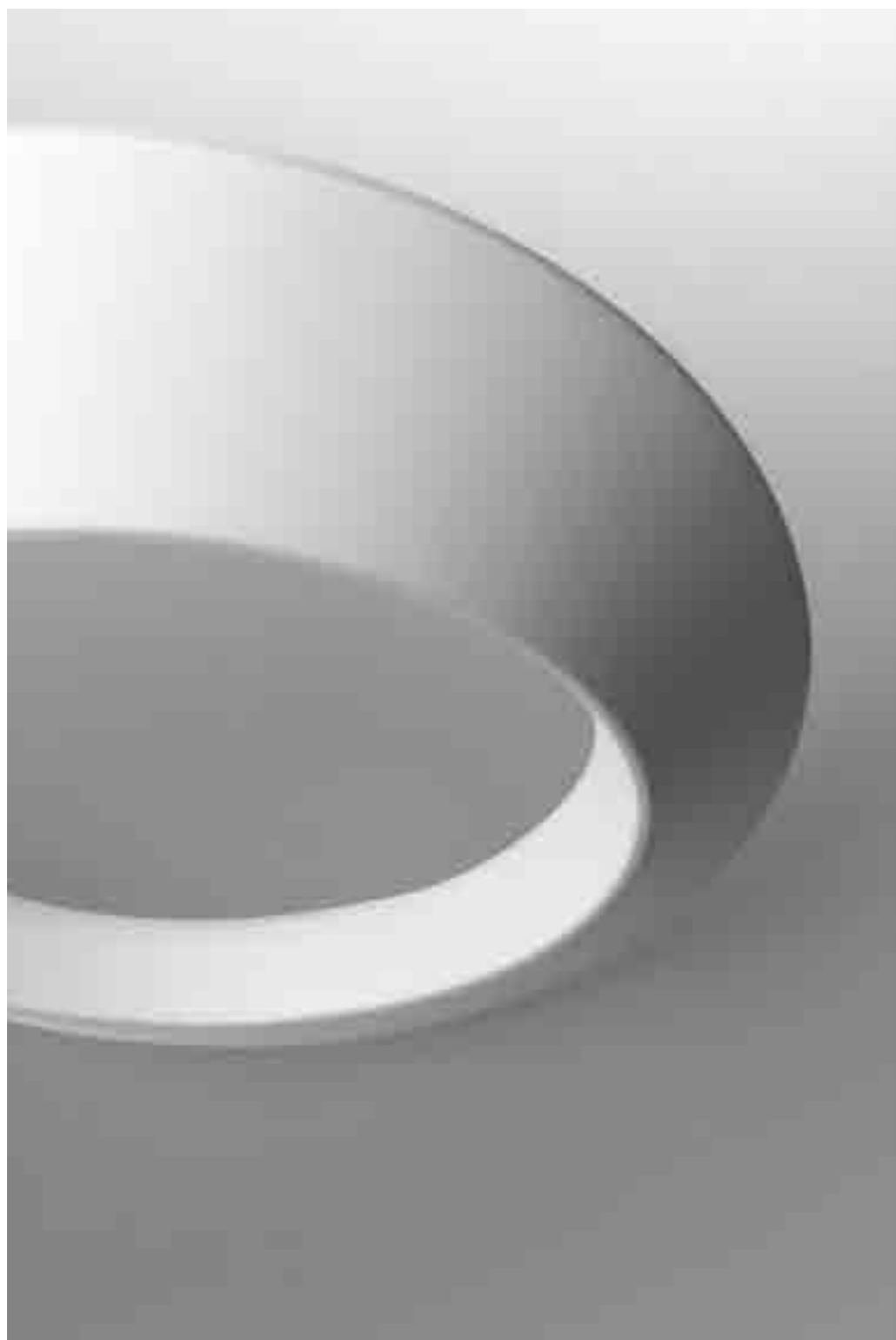

# OLO WALL

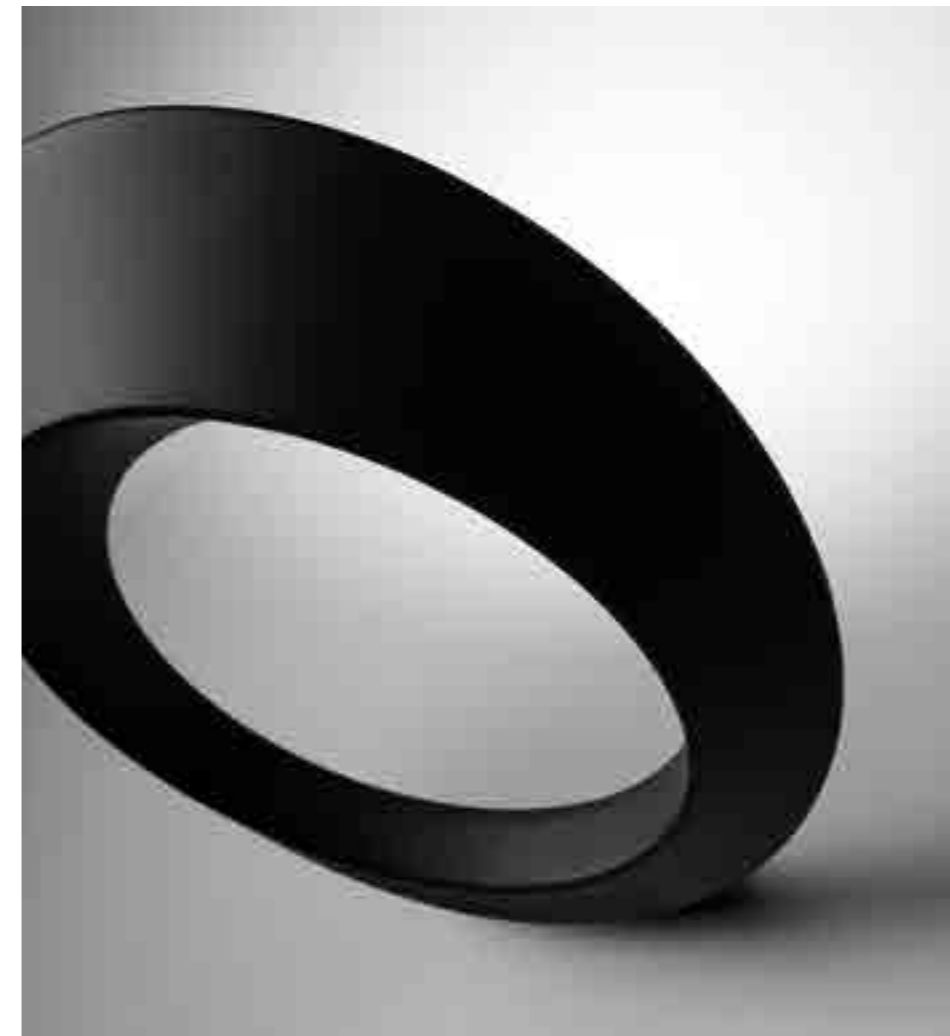



OLO WALL







OLO WALL

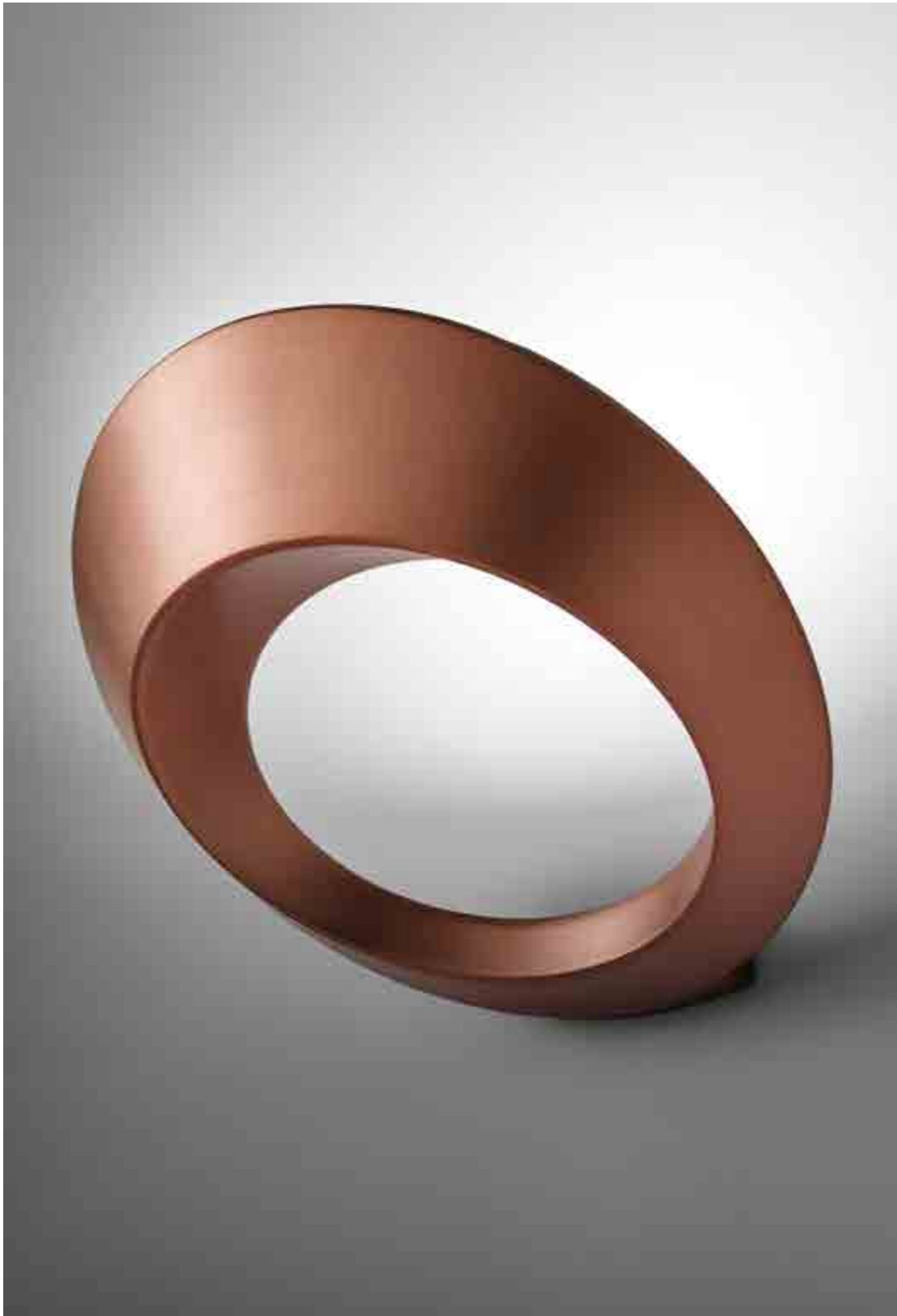



OLO WALL



OLO WALL



OLO WALL





OLO WALL



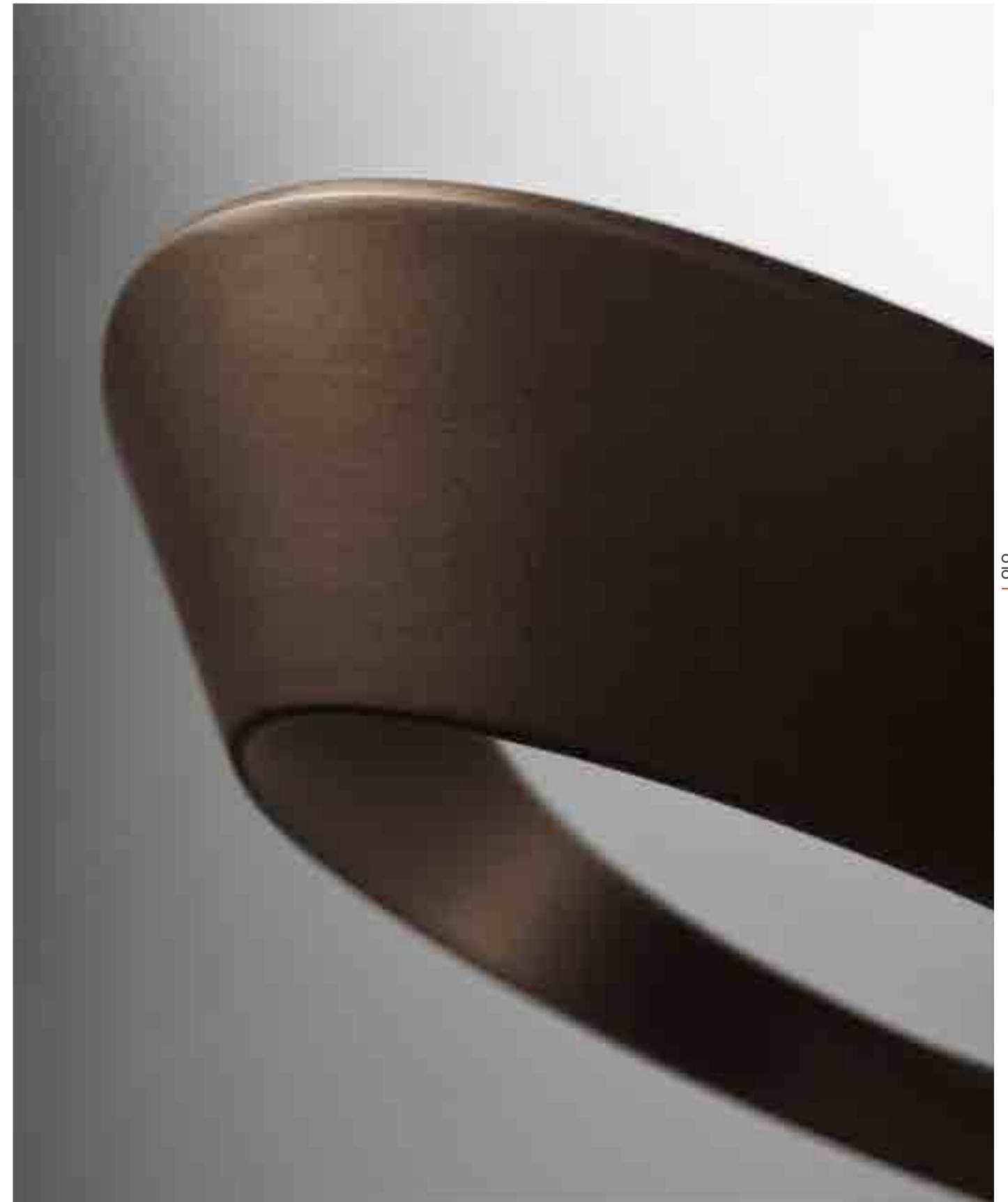

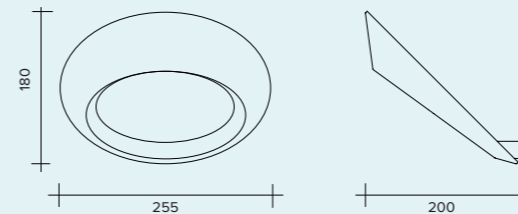
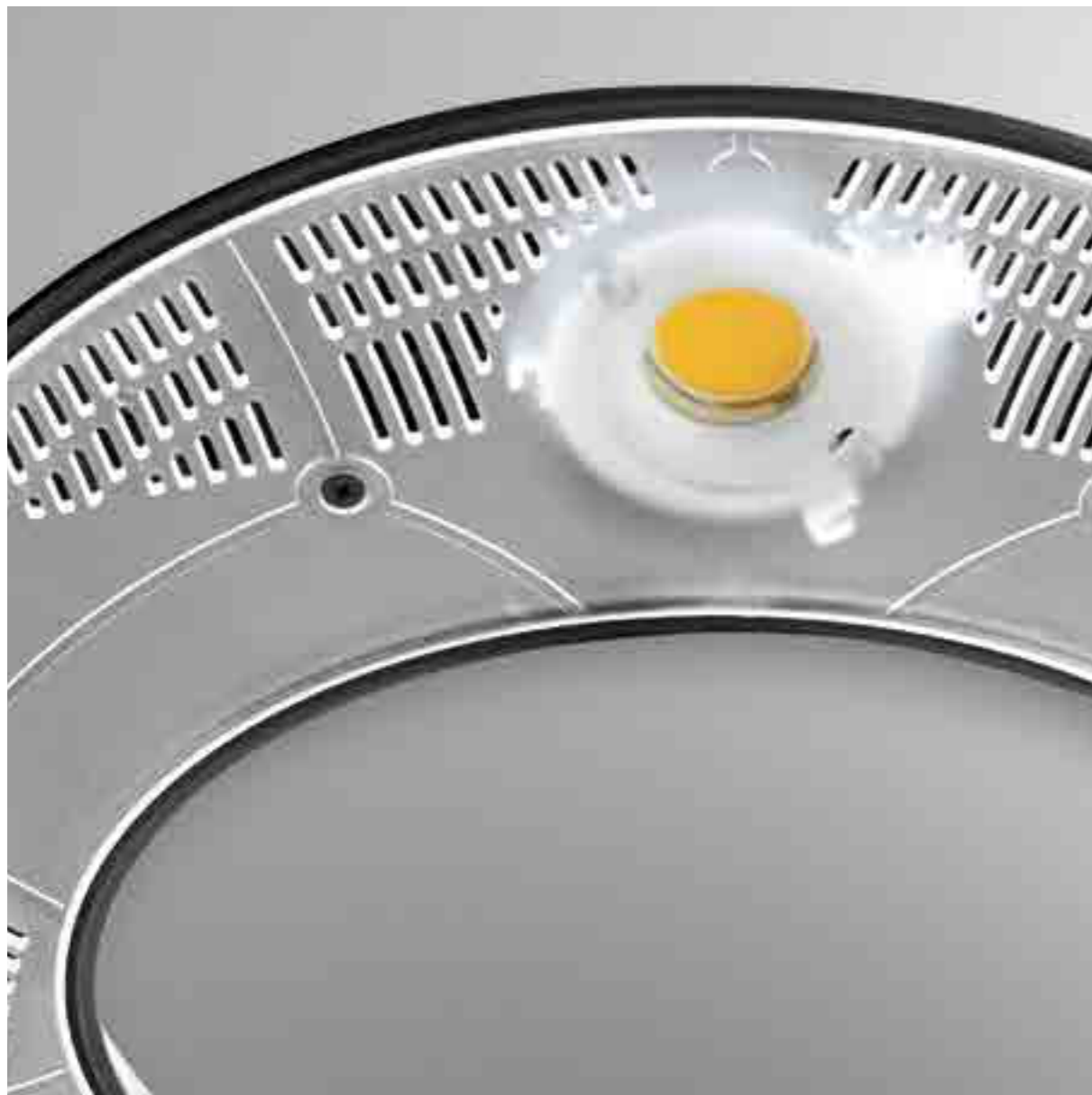

## OLO

### Wall

Lampada da parete  
Wandleuchte  
Lámpara de pared  
Настенная лампа



#### FINISHES / FINITURE / FARBE / ACABADOS / ОТДЕЛКИ

- |  |   |   |
|--|---|---|
| ● White / Bianco / Weiß<br>Blanco / Белый цвет   | ● Black / Nero / Schwarz<br>Negro / Чёрный цвет   | ● Brushed gold / Oro spazzolato / Gold gebürstet<br>Oro cepillado / Брашированное золото  |
| ● Brushed copper / Rame spazzolato<br>Kupfer gebürstet / Cobre cepillado /<br>Брашированная медь | ● Brushed bronze / Bronzo spazzolato<br>Bronze gebürstet / Bronce cepillado<br>Брашированная бронза | ● Brushed black nickel / Nichel nero spazzolato<br>Nickel schwarz gebürstet / Níquel negro cepillado<br>Брашированный черный никель |

#### LIGHT SOURCE / SORGENTE / LICHTQUELLE / FUENTE LUMINOSA / ИСТОЧНИК СВЕТА

LED 33W - 230V 2700°K / 3085 lumen  
3000°K / 3300 lumen  
4000°K / 3515 lumen

#### RECOMMENDED DIMMER SWITCHES / DIMMER CONSIGLIATI / EMPFOHLENE DIMMER / REGULADORES DE INTENSIDAD ACONSEJADOS / РЕКОМЕНДУЕМЫЕ ДИММЕРЫ

##### code 1776.CASAMBI

Bluetooth dimmer, controls up to 4 lights, remote installation.  
Dimmer Bluetooth, gestisce fino a 4 lampade, installazione in remoto.  
Bluetooth-Dimmer, verwaltet bis zu 4 Lampen, Ferninstallation.  
Regulador de intensidad luminosa Bluetooth, para el control de hasta 4 lámparas, instalación a distancia.  
диммер bluetooth, позволяющий подключить до 4 ламп, удаленная установка.

##### code 1776.DIM

Phase cut dimmer, 230V AC, in/out, controls up to 6 lights, adjustable minimum setting, remote installation.  
Dimmer a taglio di fase 230vac, in/out, gestisce fino a 6 lampade, minimo programmabile, installazione in remoto.  
Phasendimmer 230Vac, Ein-/Ausgang, verwaltet bis zu 6 Lampen, Minimum programmierbar, Ferninstallation.  
Regulador de intensidad luminosa por corte de fase 230 Vca, in/out, para el control de hasta 6 lámparas, mínimo programable, instalación a distancia.  
диммер с отсечкой фазы 230В перем. тока, вход/выход, позволяющий подключить, до 6 ламп; минимальный уровень диммирования программируемый, удаленная установка.

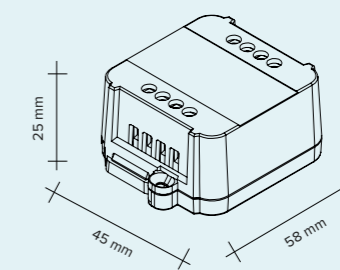
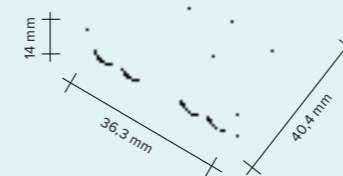

#### HOLE COVER / COPRIFORO / LOCHABDECKUNG / ТАПАОРИФИЦИО / ЗАГЛУШКА

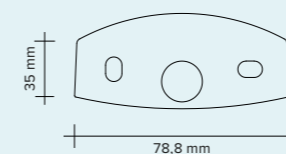

Wall hole cover plate in metal, painted white.  
Supplied standard, used for installations on walls with large sized holes.  
Piastrina copriforo parete in metallo, verniciata bianca. Fornita di serie, utile per installazioni su pareti con fori di grandi dimensioni.  
Lochabdeckung für Wände, aus Metall, weiß lackiert. Wird serienmäßig mitgeliefert und ist nützlich bei einer Installation an der Wand, wenn das Loch einen großen Durchmesser hat.  
Placa tapaorificio de metal para pared, pintada de blanco.  
Suministrada de serie, útil para instalaciones en paredes con orificios grandes.  
Металлическая накладка для покрытия настенных отверстий, окрашенная в белый цвет. Накладка входит в комплект поставки и хорошо подходит для установки на стены с отверстиями большого размера.



# ANELLO

SUSPENSION

design Sforzin Illuminazione

## ANELLO COLLECTION

The purest form in its most minimal declination.  
A perfect circle described in space by a thin, precise, aluminum body.  
A continuous thread of light, inside the circle, illuminates the environment consistently, always with discretion.  
A dimmable version is also available.

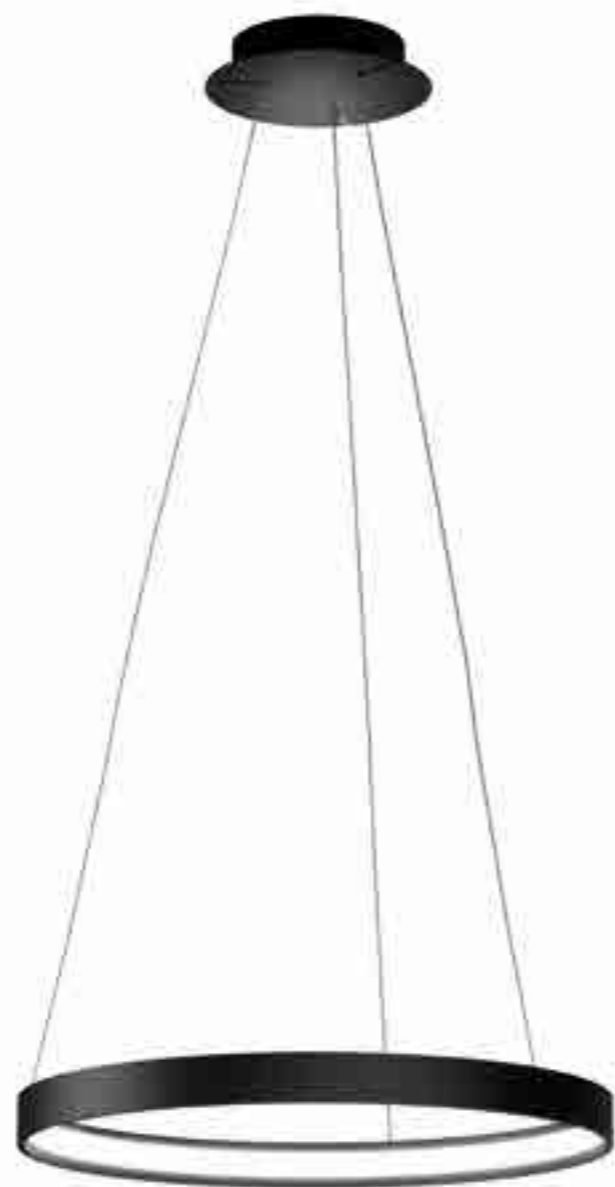

### ANELLO

La forma più pura nella sua declinazione più minimale.  
Un cerchio perfetto descritto nello spazio da un sottile, preciso, corpo in alluminio.  
Un filo continuo di luce, interno al cerchio, illumina l'ambiente uniformemente, sempre con discrezione.  
Disponibile anche in versione dimmerabile.

### ANELLO

Die reinste Form in ihrer schlichtesten Ausführung.  
Ein perfekter Kreis der im Raum durch einen dünnen, präzisen Aluminiumkörper definiert wird.  
Ein durchgehender Lichtfaden im Inneren des Kreises beleuchtet die Umgebung gleichmäßig und immer diskret.  
Version erhältlich.

### ANELLO

La forma más pura en su más mínima declinación.  
Un cuerpo de aluminio fino y preciso describe en el espacio un círculo perfecto.  
Un hilo de luz continuo, dentro del círculo, ilumina uniformemente el lugar, siempre con discreción.  
Disponibile también en la versión con intensidad luminosa regulable.

### ANELLO

Самая чистая форма в самом минималистическом виде  
Идеально ровный круг, выделенный в пространстве тонким и точным алюминиевым корпусом.  
Непрерывный поток света, внутри круга, равномерно и всегда умеренно освещает помещение.  
Предлагается и диммируемый вариант.



# ANELLO SUSPENSION





# ANELLO SUSPENSION



# ANELLO

SUSPENSION

design Sforzin Illuminazione



ANELLO

# ANELLO SUSPENSION

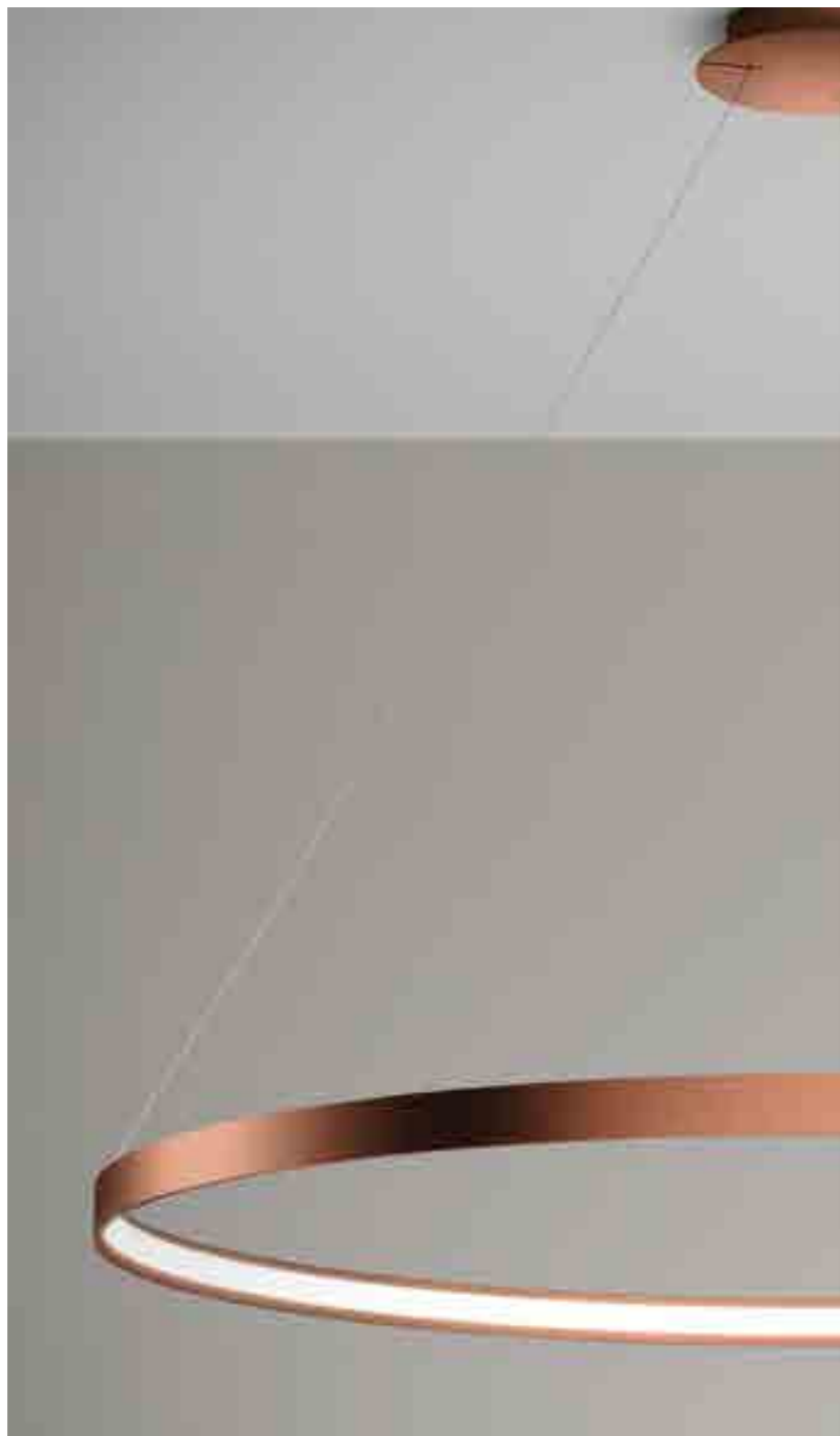

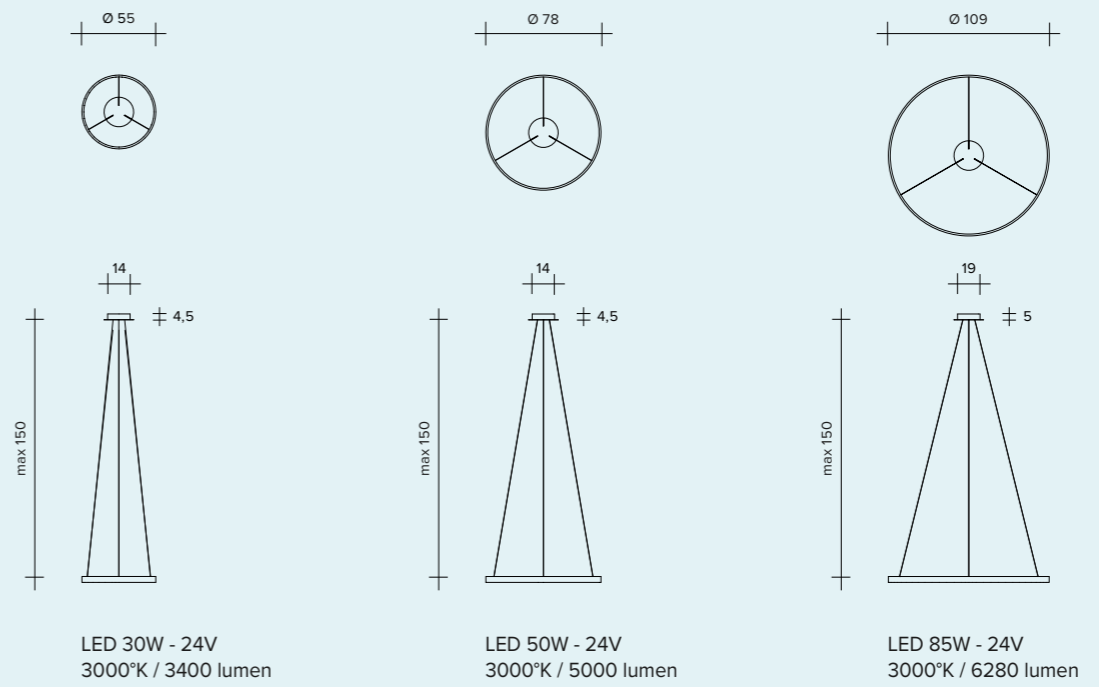

## ANELLO Suspension

*Lampada a sospensione*  
*Pendelleuchte*  
*Lámpara colgante*  
*Подвесная лампа*

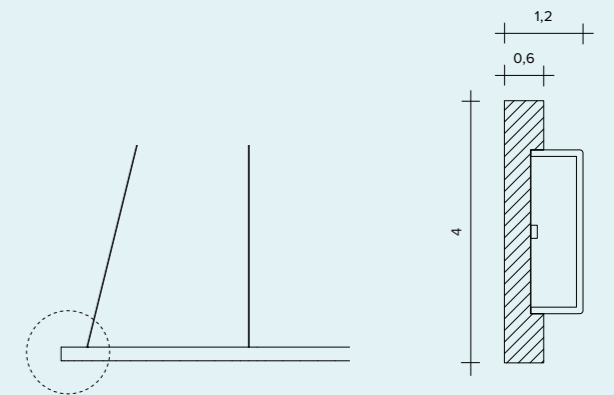

### FINISHES / FINITURE / FARBE / ACABADOS / ОТДЕЛКИ

- Painted black / Nero Verniciato / Schwarz lackiert  
Negro Pintado / Окрашенный в черный цвет
- Brushed Bronze / Bronzo Spazzolato / Bronze gebürstet  
Bronce cepillado / Брашированная бронза
- Brushed Gold / Oro Spazzolato / Gold gebürstet  
Oro cepillado / Брашированное золото
- Brushed Copper / Rame Spazzolato / Kupfer gebürstet  
Cobre cepillado / Брашированная медь

# LAMOI

## NEW FINISHES

design **Andrea Barra**

### LAMOI COLLECTION

Magical collection of LED lamps: suspension lamps, ceiling lights and floor lamps.

The metal, an electrical conductor, is available in four colours (black nickel, chrome, copper or gold) and can be used to supply power to and turn on the 1W LED modules.

Available in 2700°K and 3000°K versions.

Dimmable and non-dimmable, optional cover.

### LAMOI COLLEZIONE

Magica collezione di lampade a led: Sospensioni, Plafoniere e Piantane. Il metallo conduttore di corrente, disponibile nei colori nickel nero, cromo, rame, e oro permette di alimentare e accendere i moduli led da 1 w. Disponibili in 2700°K e 3000°K. Dimmerabile e non, coperture optional.

### LAMOI KOLLEKTION

Eine magische LED-Leuchten Kollektion: Hängeleuchten, Deckenleuchten und Stehleuchten. Das stromleitende Metall ist in den Farben Nickel schwarz, Chrom, Kupfer und Gold erhältlich und dient zum Speisen und Einschalten der 1W LED-Module. Erhältlich mit 2700°K und 3000°K. Dimmerbar und nicht dimmerbar, Abdeckungen optional.

### LAMOI COLECCIÓN

Colección mágica de lámparas de led: De suspensión, plafones y de pie. El metal, conductor de corriente, disponible en los colores níquel negro, cromo, cobre y oro, permite alimentar y encender los módulos led de 1 w. Disponibles con temperaturas de color de 2700°k y 3000°k. De intensidad luminosa regulable y fija, coberturas opcionales.

### КОЛЛЕКЦИЯ LAMOI

Волшебная коллекция светодиодных ламп: подвесные, потолочные и опорные. Токпроводящий металл цвета черного никеля, хрома, меди или золота позволяет питать и включать светодиодные модули мощностью 1 Вт. Имеются модели на 2700°K и 3000°K. С диммером и без, крышки не входят в базовую комплектацию.



LAMOI  
NEW FINISHES

SUSPENSION



LAMOI



LAMOI  
SUSPENSION  
NEW FINISHES

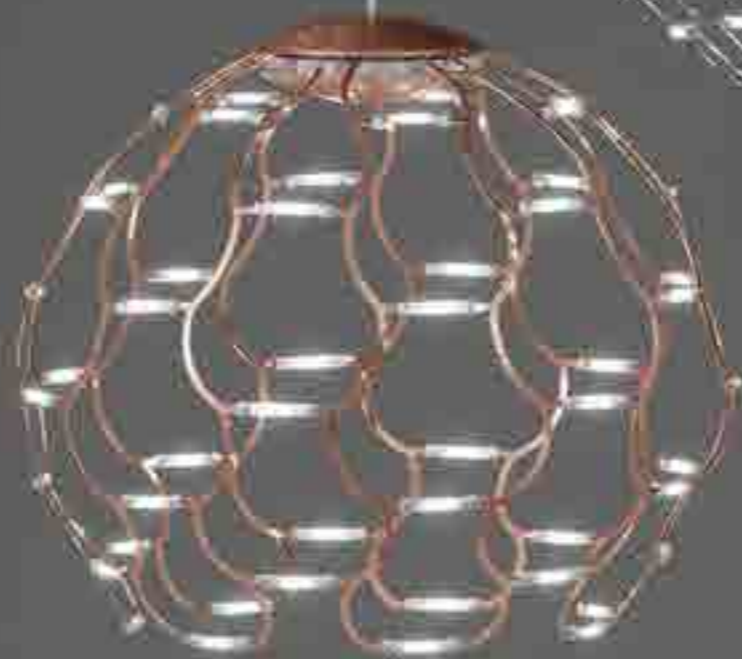
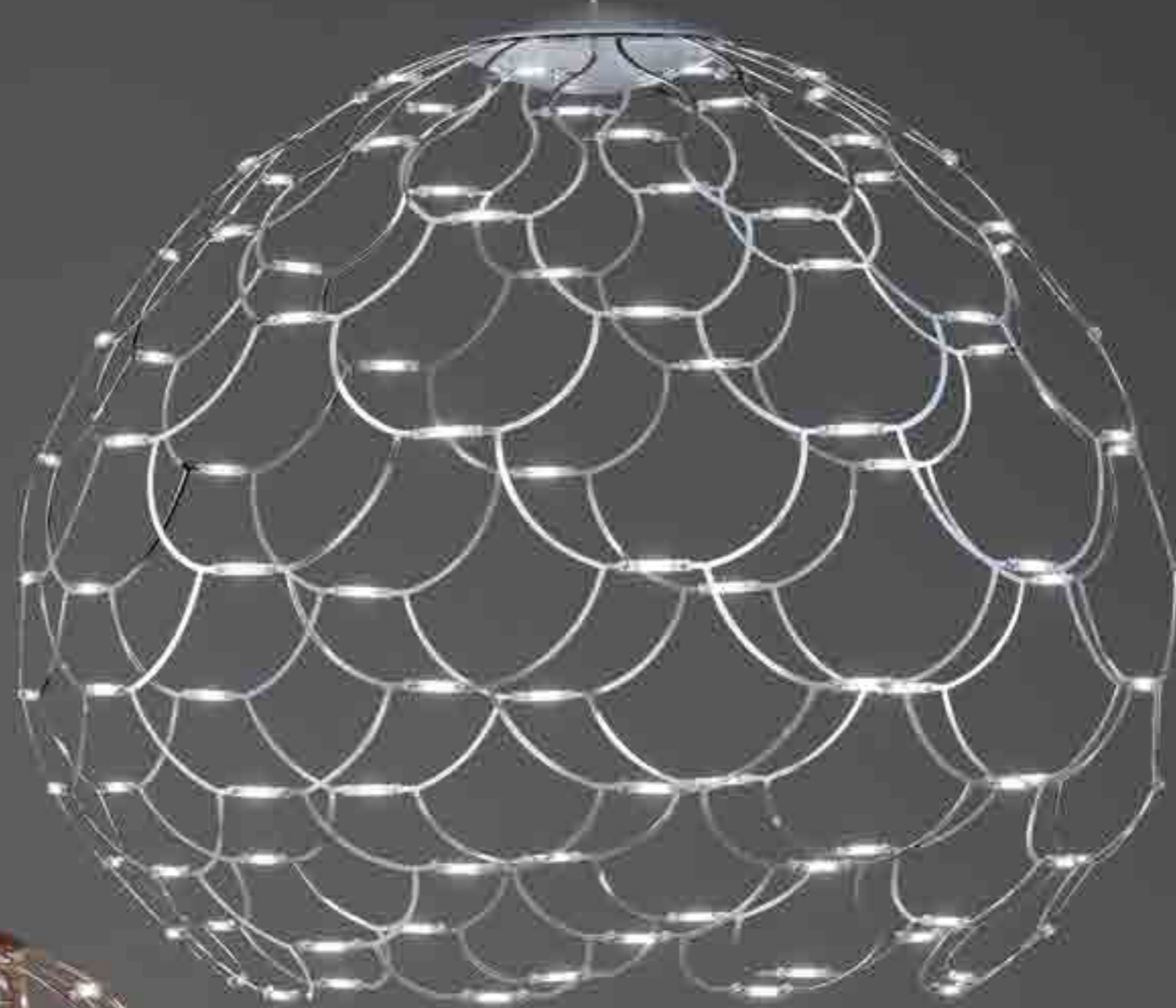
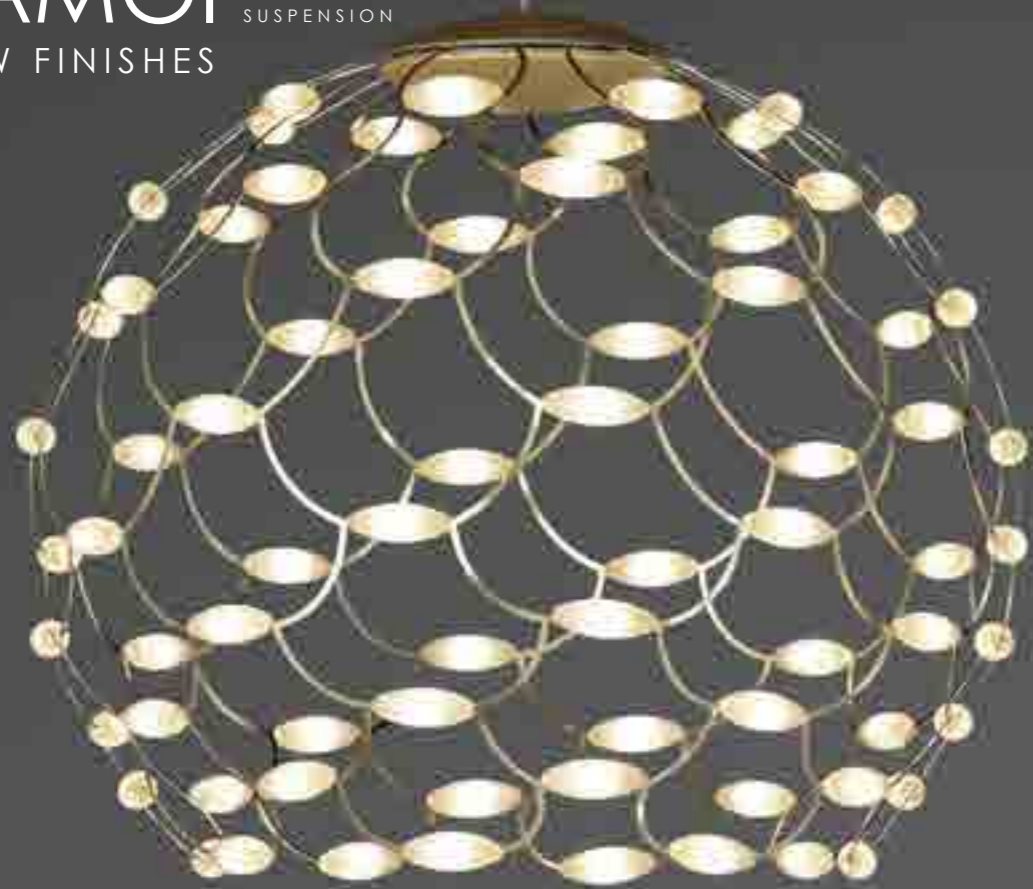

LAMOI SUSPENSION  
NEW FINISHES





LAMOI SUSPENSION  
NEW FINISHES



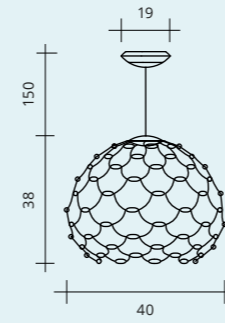
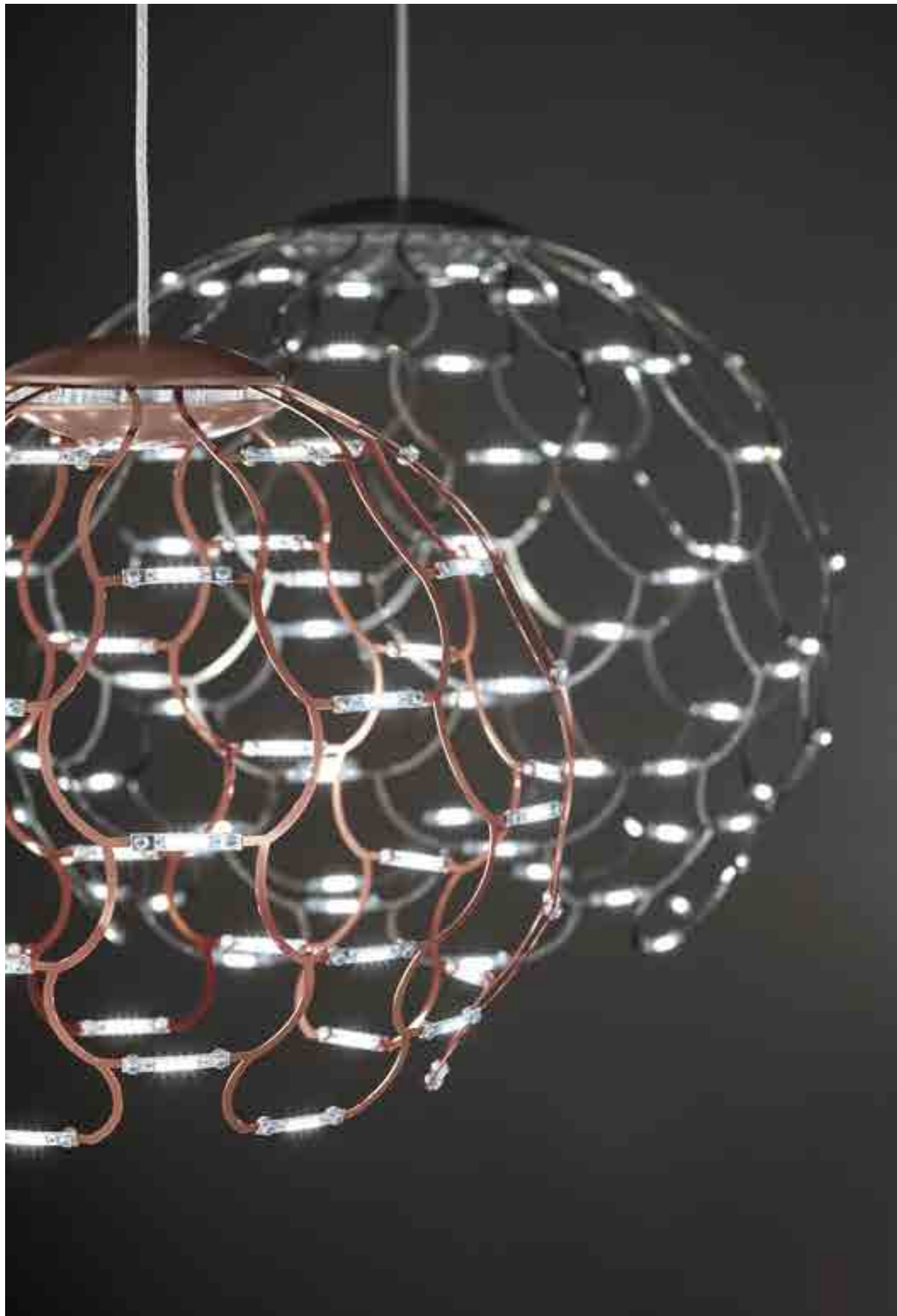

LED 49W - 24V  
2700°K / 3675 lumen  
3000°K / 3920 lumen

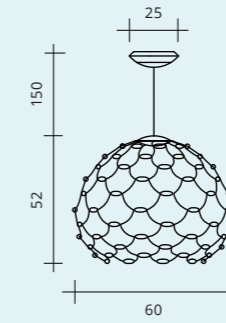

LED 72W - 24V  
2700°K / 5400 lumen  
3000°K / 5760 lumen

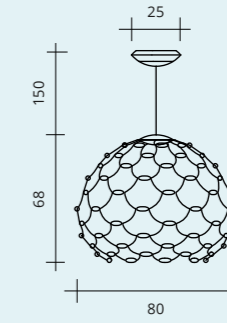

LED 99W - 24V  
2700°K / 7425 lumen  
3000°K / 7920 lumen

## LAMOI

### Suspension

*Lampada a sospensione*  
*Pendelleuchte*  
*Lámpara colgante*  
*Подвесная лампа*



### FINISHES / FINITURE / FARBE / ACABADOS / ОТДЕЛКИ

- Copper / Rame / Kupfe / Cobre / Медь
- Chrome / Cromo / Chrom / Cromo / Хром
- Black / Nero / Schwarz / Negro / Чёрный цвет
- Gold / Oro / Kupfe / Gold / Золото

LAMOI  
NEW FINISHES

CEILING





LAMOI CEILING  
NEW FINISHES



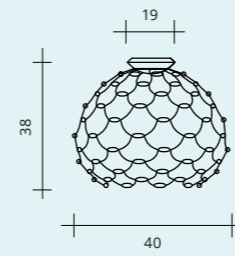
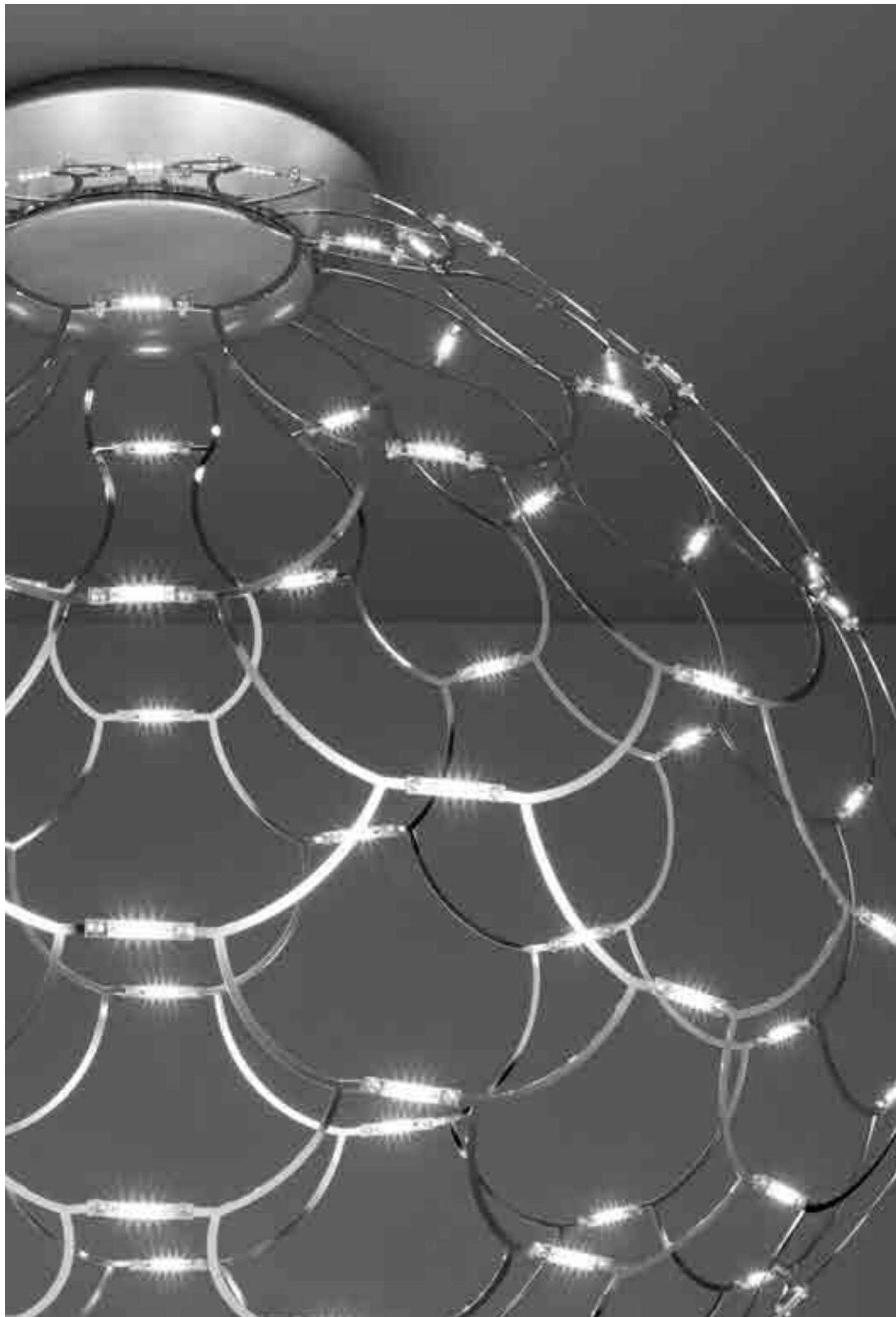

LED 49W - 24V  
2700°K / 3675 lumen  
3000°K / 3920 lumen

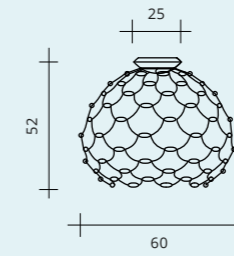

LED 72W - 24V  
2700°K / 5400 lumen  
3000°K / 5760 lumen

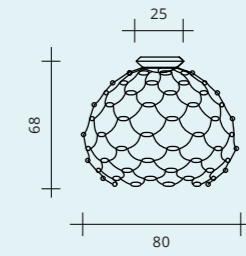

LED 99W - 24V  
2700°K / 7425 lumen  
3000°K / 7920 lumen

## LAMOI Ceiling light

*Lampada da soffitto*  
*Deckenleuchte*  
*Lámpara de techo*  
*Потолочная лампа*



### FINISHES / FINITURE / FARBE / ACABADOS / ОТДЕЛКИ

- Copper / Rame / Kupfe / Cobre / Медь
- Chrome / Cromo / Chrom / Cromo / Хром
- Black / Nero / Schwarz / Negro / Чёрный цвет
- Gold / Oro / Kupfe / Gold / Золото

# LAMOI

FLOOR LAMP  
NEW FINISHES

Picture shows  
the LAMOI Floor  
touch dimmer.

*Immagine raffigurante  
touch dimmer della  
LAMOI Terra.*

*Das Bild zeigt den  
Touch Dimmer des LAMOI  
Stehleuchten modells.*

*La imagen muestra  
el regulador touch  
de luminosidad de la  
LAMOI Tierra Cobre.*

*На изображении  
представлен сенсорный  
диммер светильника  
LAMOI Terra.*





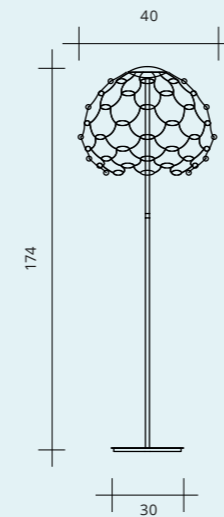
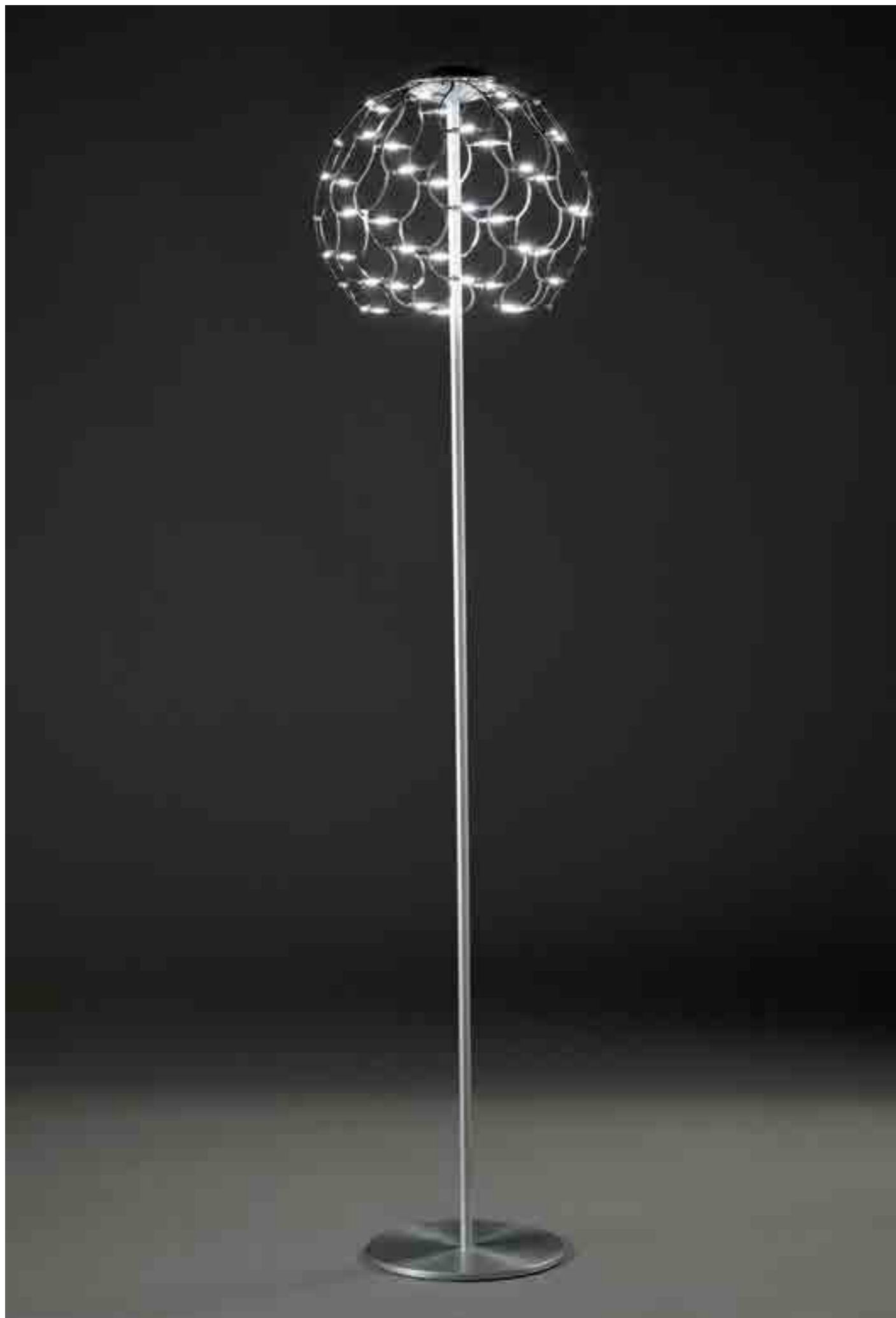

LED 49W - 24V  
2700°K / 3675 lumen  
3000°K / 3920 lumen

## LAMOI Floor lamp

*Lampada da terra*  
*Stehleuchte*  
*Lámpara de pie*  
*Напольная лампа*



### FINISHES / FINITURE / FARBE / ACABADOS / ОТДЕЛКИ

- Copper / Rame / Kupfe / Cobre / Медь
- Chrome / Cromo / Chrom / Cromo / Хром
- Black / Nero / Schwarz / Negro / Чёрный цвет
- Gold / Oro / Kupfe / Gold / Золото

# TESA MINI

design Marco Spatti

## TESA MINI COLLECTION

A more compact version of the Tesa, its bigger sister. The LED lights and metal frame blend together into a single piece, creating an elegant light of great visual impact.

The design plays on a mix of solids and voids, with glittering sparkles and reflections.

Available in 2700°K and 3000°K versions.

Dimmable and non-dimmable.

Three colours: polished chrome, black nickel and copper.

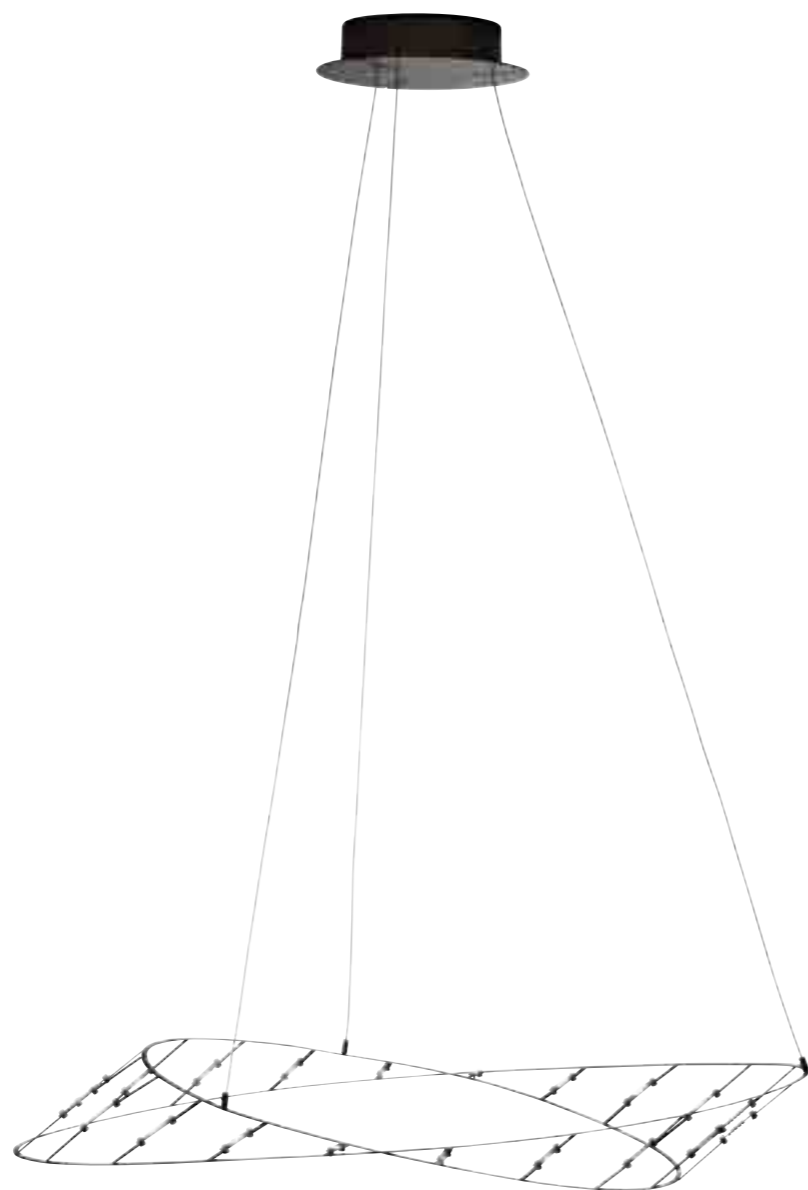

### TESA MINI

Versione compatta della sorella maggiore Tesa. Led e struttura metallica si fanno corpo unico dando vita ad una lampada elegante dal grande impatto visivo. Un gioco fatto di pieni e vuoti, di scintillii e riflessi. Disponibile 2700°k e 3000°k. Dimmerabile e non. Tre colori: cromo lucido, nickel nero e rame.

### TESA MINI

Kompakte Version der großen Schwester Tesa. Led und Metallstruktur werden zu einem einzigen Körper und kreieren eine elegante Lampe mit großer optischer Wirkung. Ein Spiel aus vollen und leeren Räumen, Funken und Reflexionen. Erhältlich mit 2700 °K und 3000 °K. Dimmbar und nicht dimmbar. Drei Farben: poliertes Chrom, schwarzes Nickel und Kupfer.

### TESA MINI

Versión compacta de la hermana mayor Tesa. Led y estructura metálica forman un cuerpo único, creando una lámpara elegante de gran impacto visual. Un juego de lleno y vacío, de centelleos y reflejos. Disponibles 2700°k y 3000°k. Intensidad luminosa fija y regulable. Tres colores: cromo brillante, níquel negro y cobre.

### TESA MINI

Компактный вариант более импозантной модели Tesa. Светодиод и металлическая конструкция становятся единым корпусом, создавая элегантный и очень эффектный светильник. Игра полных и пустых объемов, мерцания и отражения. Существует два варианта: 2700 К и 3000 К. Диммируемый и недиммируемый. Три цвета: блестящий хром, черный никель и медь.





# TESA MINI SUSPENSION

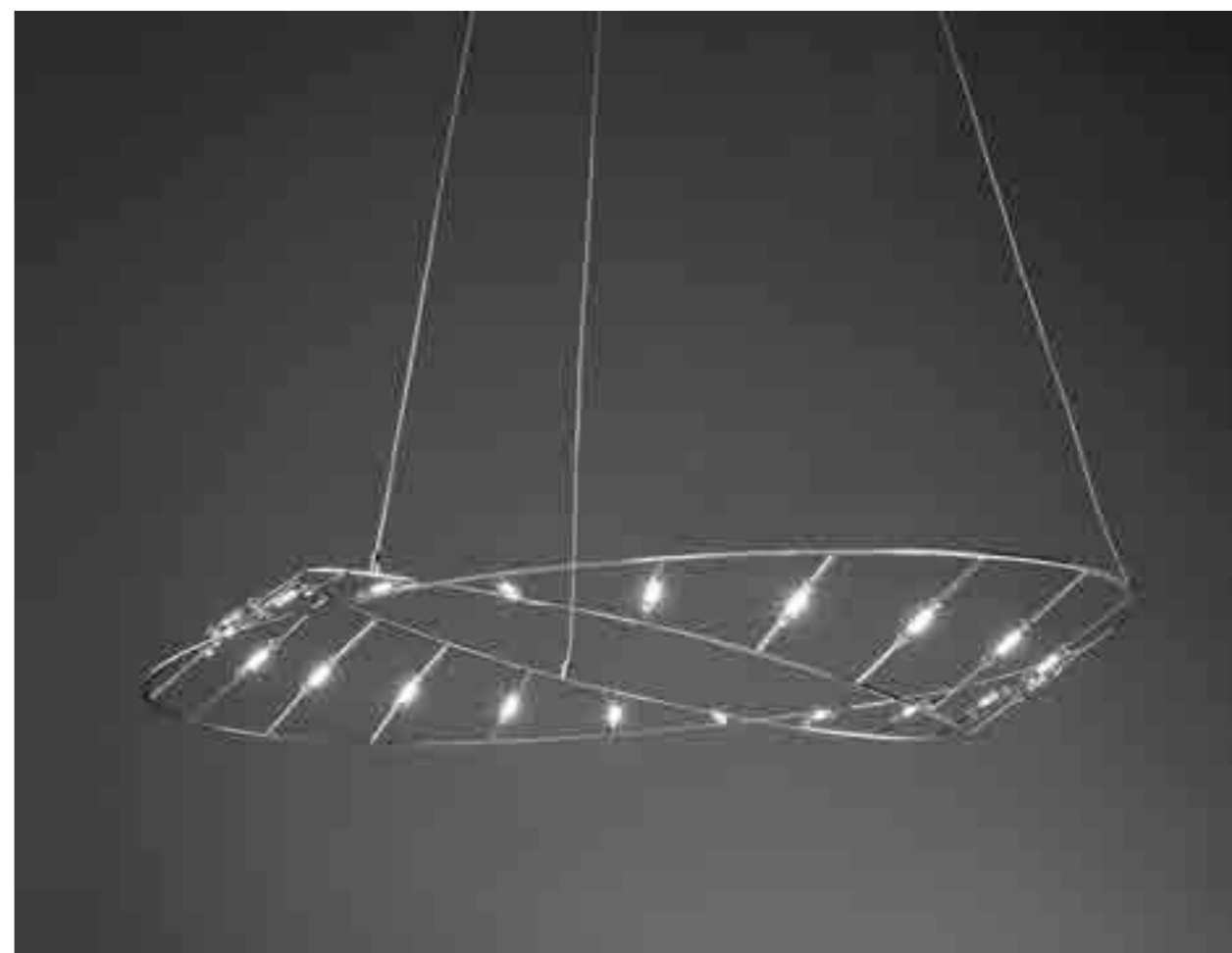

# TESA MINI SUSPENSION

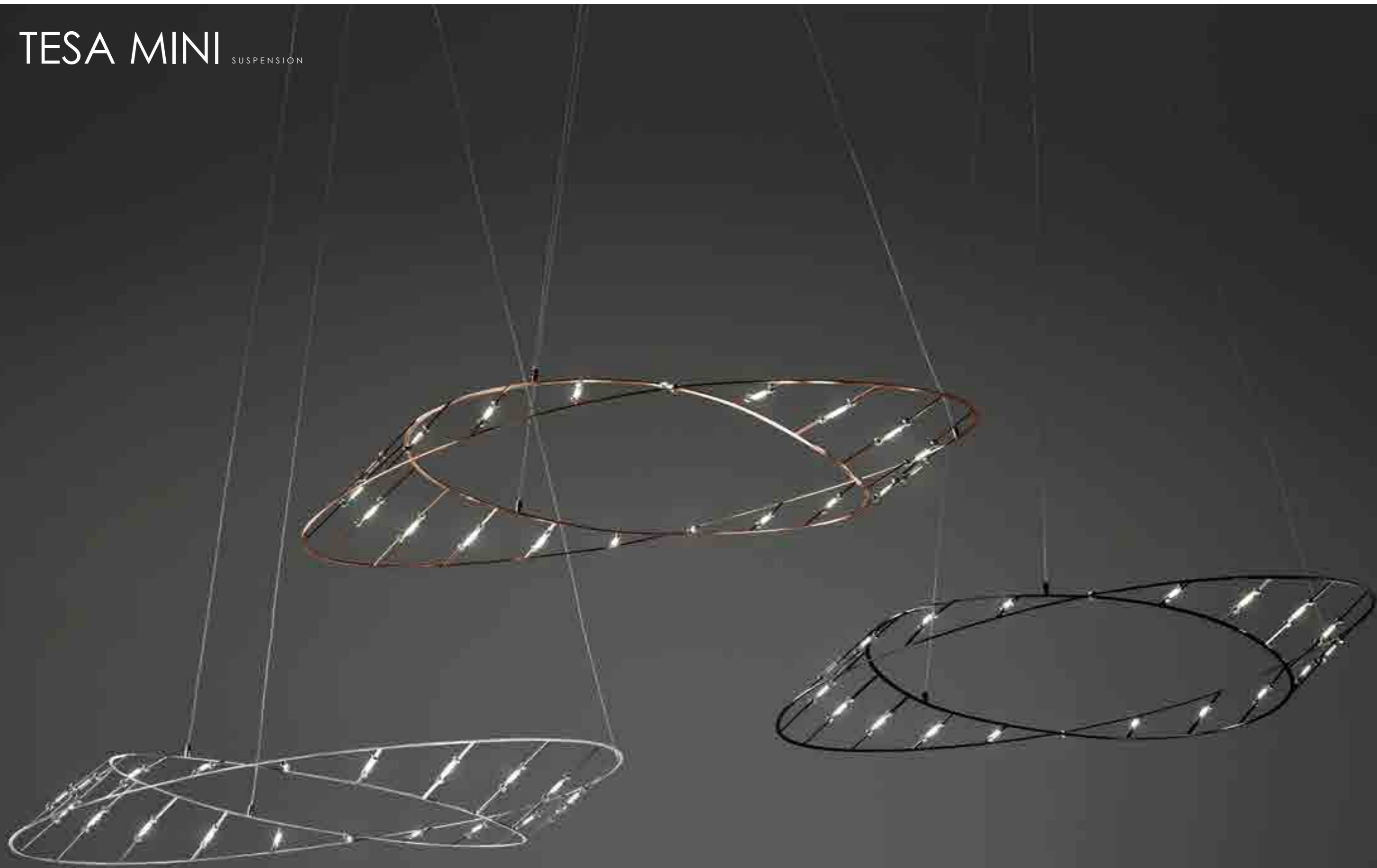

# TESA MINI CEILING

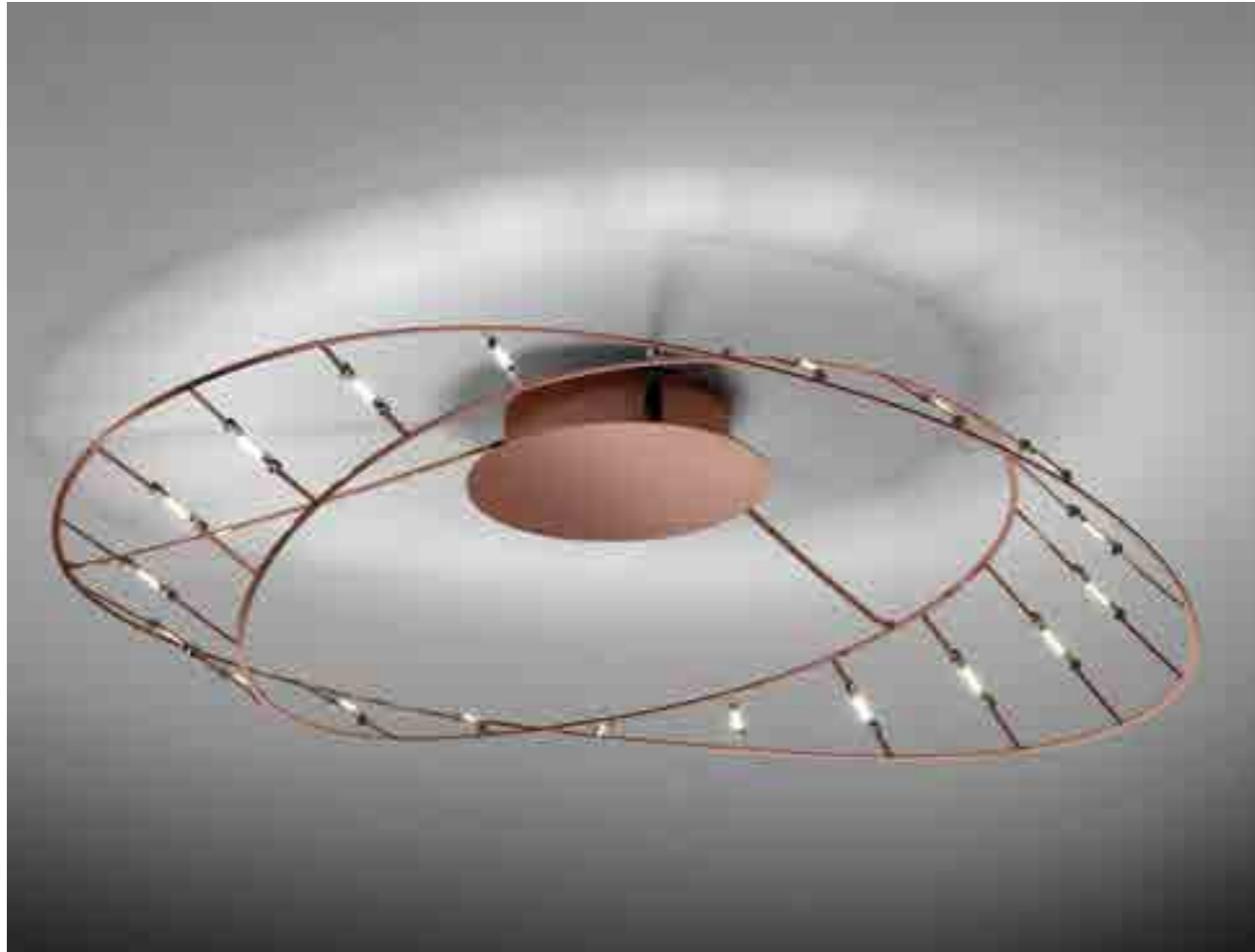

# TESA MINI CEILING

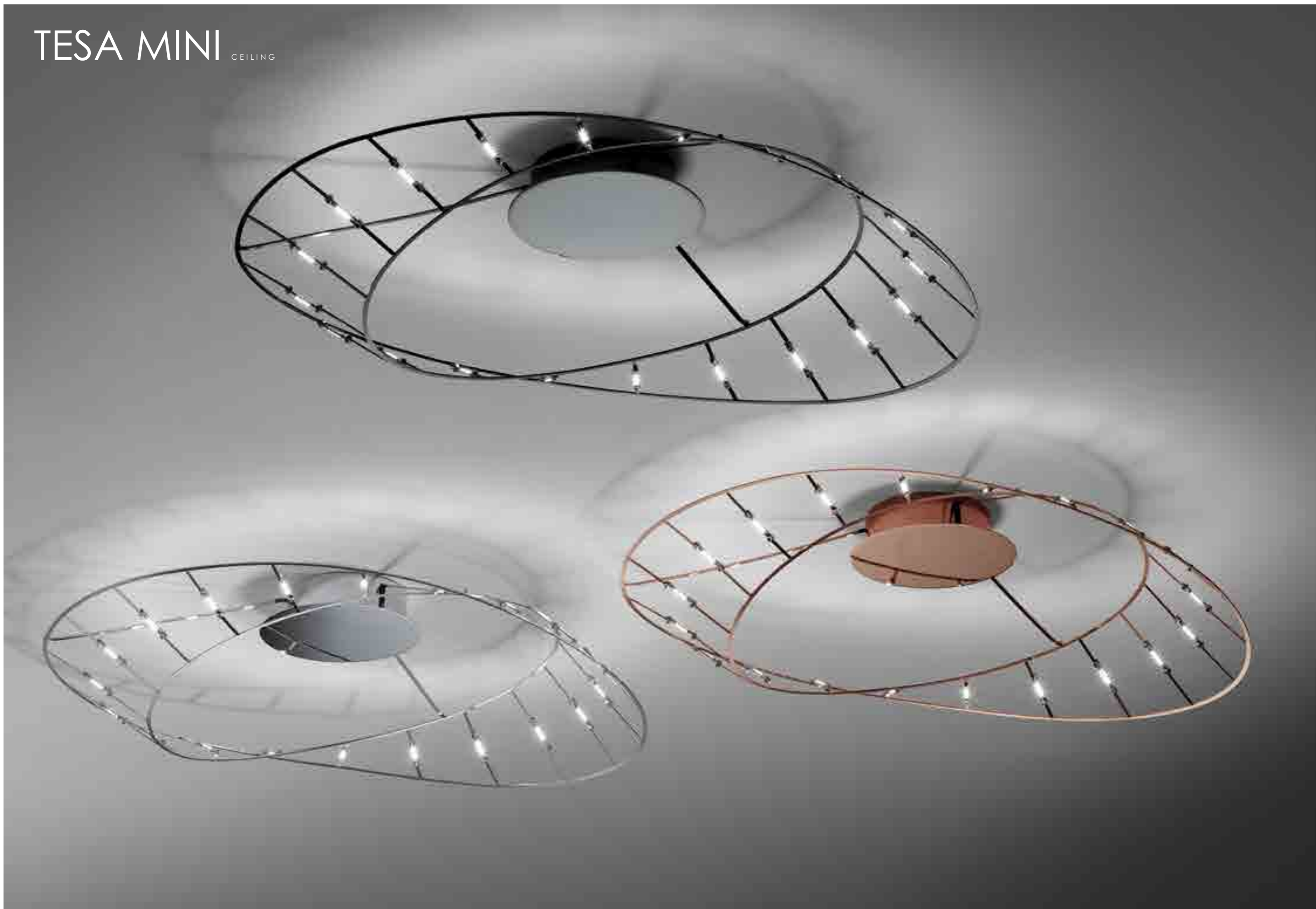

# TESA MINI CEILING

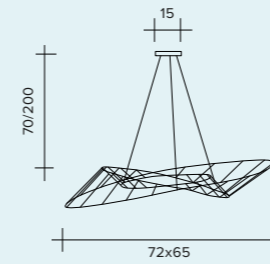
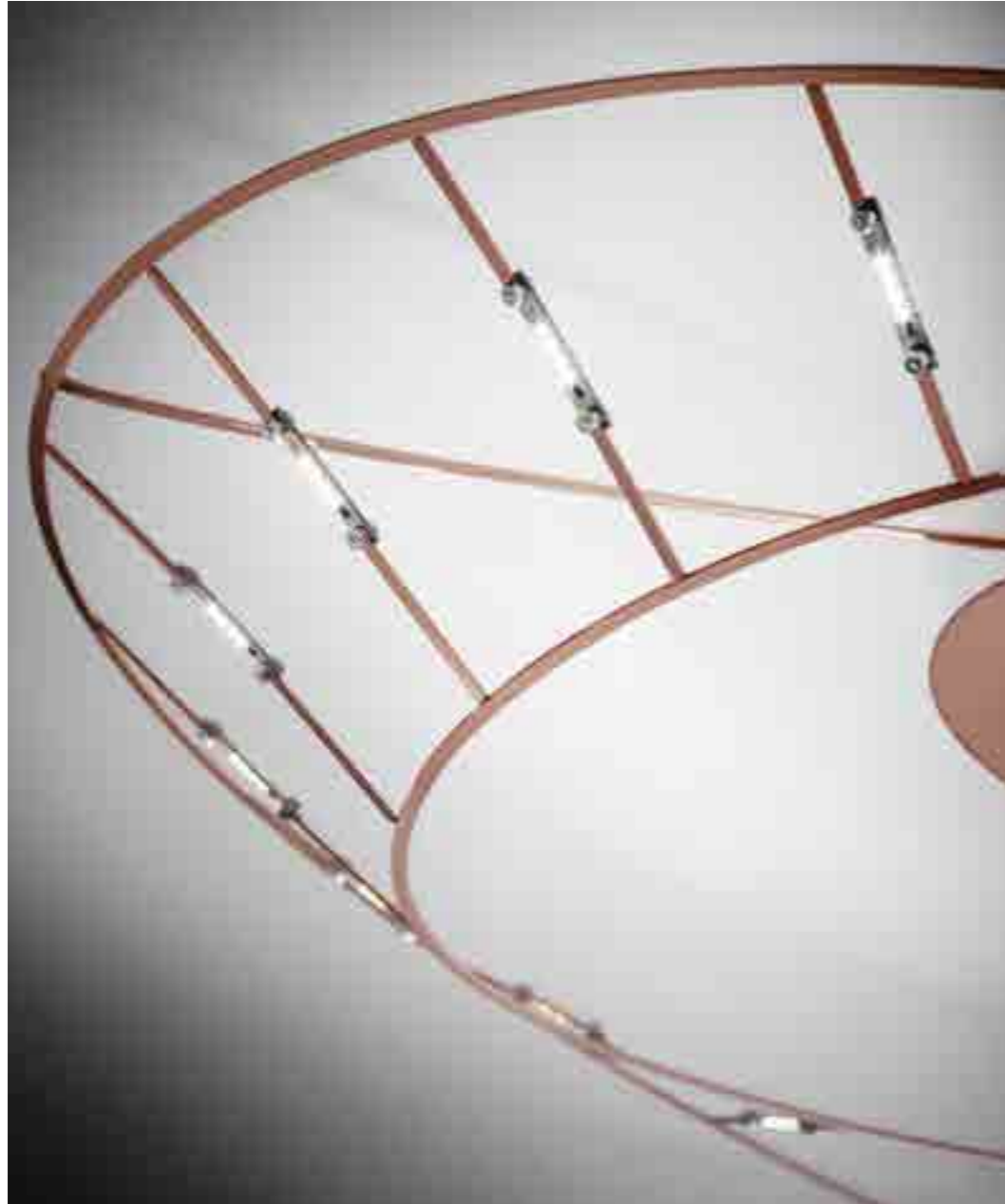

LED 20W - 24V  
2700°K / 1700 lumen  
3000°K / 1900 lumen

## TESA MINI Suspension

Lampada a sospensione  
Pendelleuchte  
Lámpara colgante  
Подвесная лампа



### FINISHES / FINITURE / FARBE / ACABADOS / ОТДЕЛКИ

- Chrome / Cromo / Chrom  
Cromo / Хром
- Black / Nero / Schwarz  
Negro / Чёрный цвет
- Copper / Rame / Kupfe  
Cobre / Медь

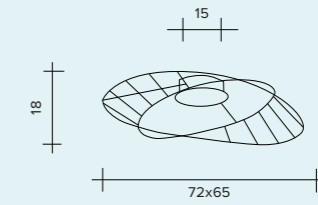

LED 20W - 24V  
2700°K / 1700 lumen  
3000°K / 1900 lumen

## TESA MINI Ceiling

Lampada da soffitto  
Deckenleuchte  
Lámpara de techo  
Потолочная лампа



### FINISHES / FINITURE / FARBE / ACABADOS / ОТДЕЛКИ

- Chrome / Cromo / Chrom  
Cromo / Хром
- Black / Nero / Schwarz  
Negro / Чёрный цвет
- Copper / Rame / Kupfe  
Cobre / Медь

# TESA

design Marco Spatti

## TESA

A lighting fixture with geometric lines. The curves of the metal give "Tesa" a balanced and harmonious look. The metal, an electrical conductor, is available in three colours (black nickel, chrome or copper) and can be used to supply power to and turn on the 1W LED modules. Available in 2700°K and 3000°K versions. Dimmable and non-dimmable.

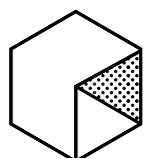

archiproducts

DESIGN AWARDS 2017

## TESA

Linee geometriche per un oggetto illuminante. La curvatura del metallo rende "Tesa" equilibrata e armonica. Il metallo, conduttore di corrente, disponibile nei colori nickel nero, cromo e rame, permette di alimentare e accendere i moduli led da 1w. Disponibile 2700°k e 3000°k. Dimmerabile e non.

## TESA

Ausgeglichenheit und Harmonie. Das stromleitende Metall ist in den Farben Nickel schwarz, Chrom und Kupfer erhältlich und dient zum Speisen und Einschalten der 1W Led-Module. Erhältlich mit 2700°K und 3000°K. Dimmerbar und nicht dimmerbar.

## TESA

Líneas geométricas para un objeto iluminador. La curvatura del metal hace de "Tesa" un objeto equilibrado y armónico. El metal, conductor de corriente, disponible en los colores níquel negro, cromo y cobre, permite alimentar y encender los módulos led de 1 w. Disponible con temperaturas de color de 2700°k y 3000°k. De intensidad luminosa regulable y fija.

## TESA

Геометрические линии в дизайне светильника. Изгибы металлических частей придают приборам "Tesa" сбалансированный и гармоничный вид. Токпроводящий металл цвета черного никеля, хрома и меди позволяет питать и включать светодиодные модули 1 Вт. Имеются модели на 2700°K и 3000°K. С диммером и без.

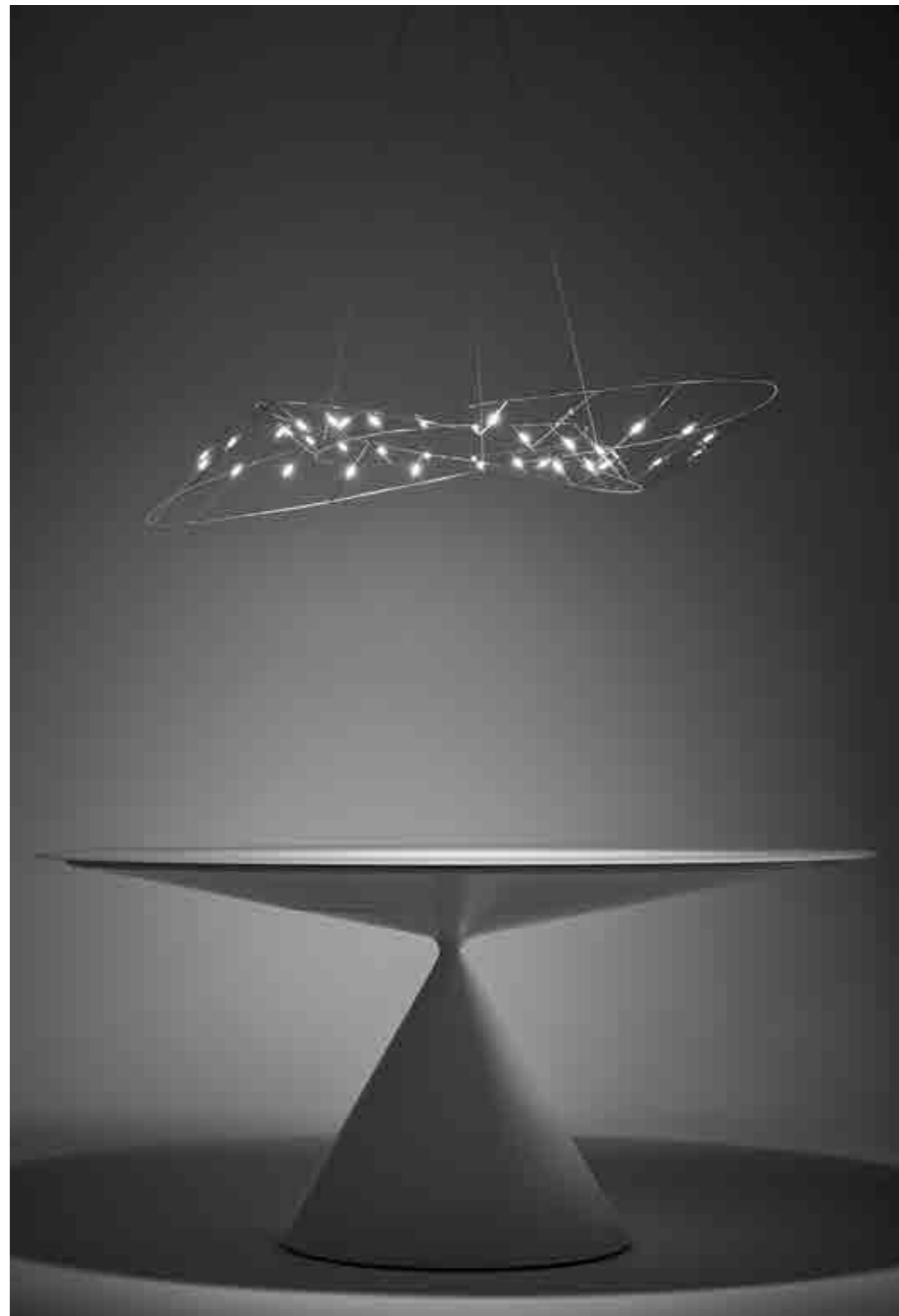



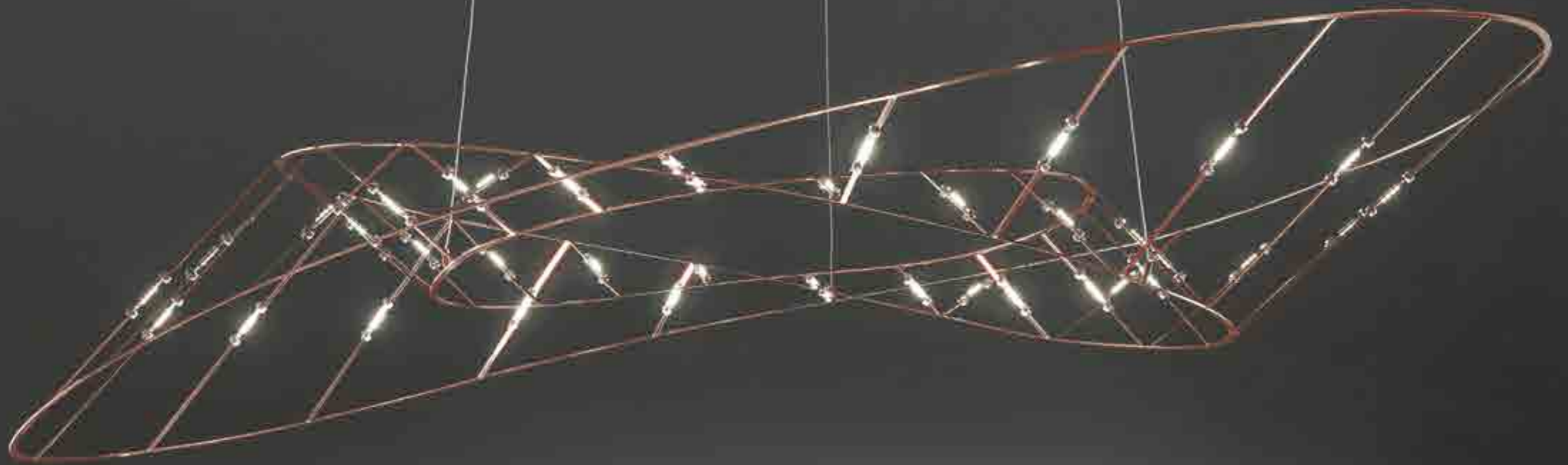

# TESA SUSPENSION

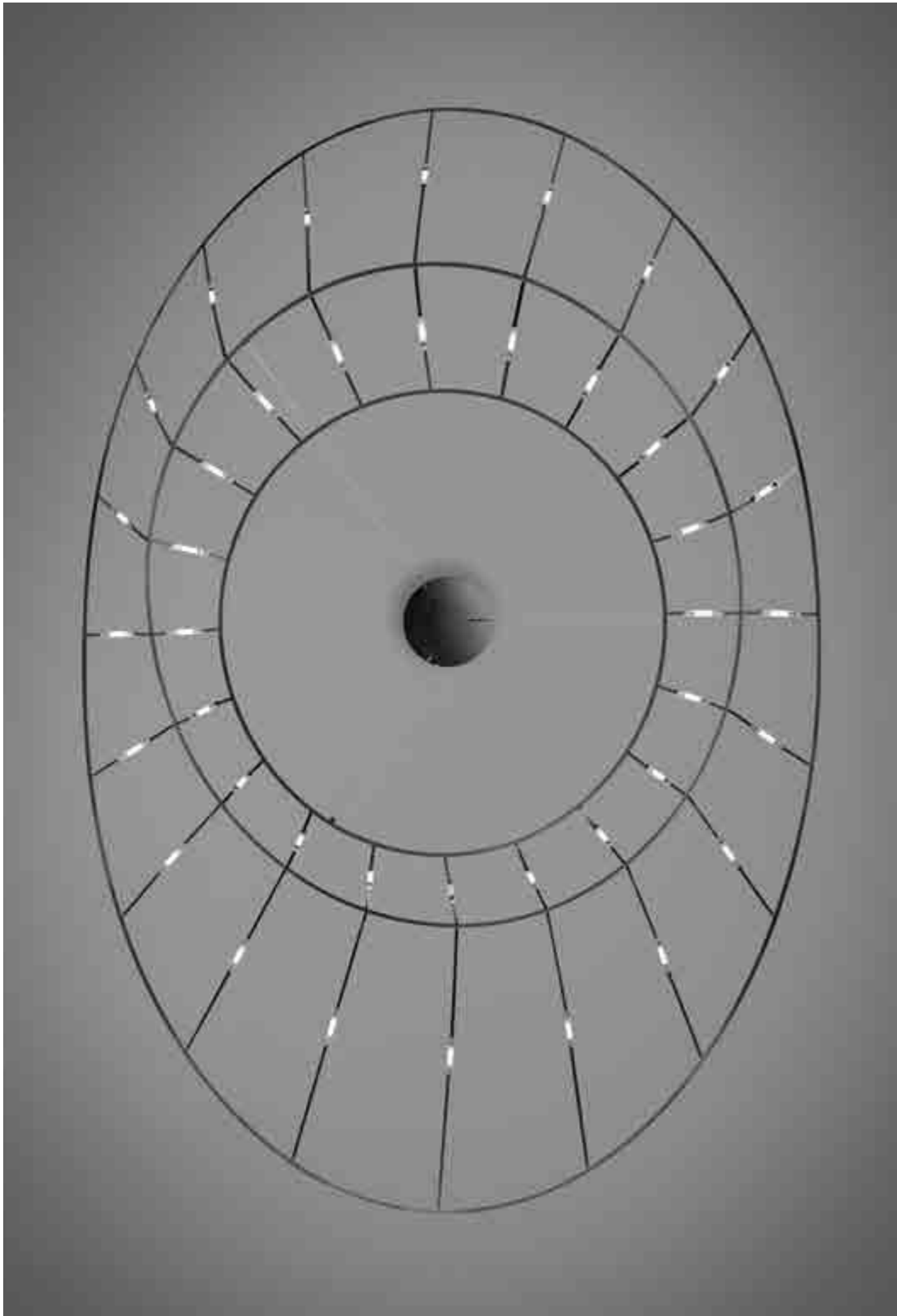

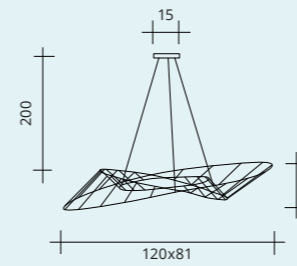
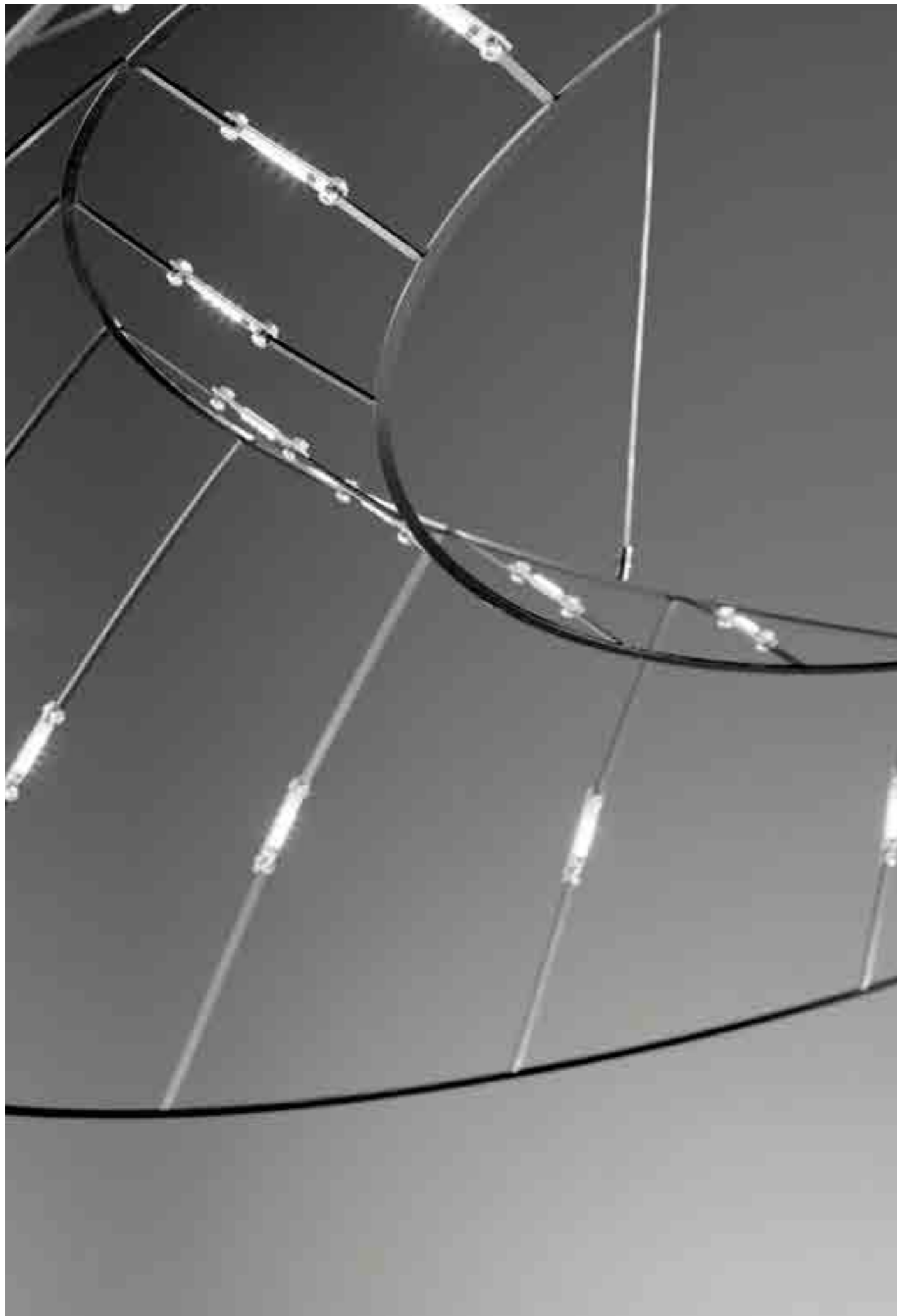

LED 40W - 24V  
2700°K / 3000 lumen  
3000°K / 3200 lumen

## TESA Suspension

*Lampada a sospensione*  
*Pendelleuchte*  
*Lámpara colgante*  
*Подвесная лампа*



### FINISHES / FINITURE / FARBE / ACABADOS / ОТДЕЛКИ

- Chrome / Cromo / Chrom / Cromo / Хром
- Black / Nero / Schwarz / Negro / Чёрный цвет
- Copper / Rame / Kupfe / Cobre / Медь

# LAFRA

design Andrea Barra

## LAFRA COLLECTION

Pure elegance and stylistic innovation.

Lafra is a range of products that meet the needs of light, technology and appearance.

The metal, an electrical conductor, is available in three colours (black nickel, chrome or copper) and can be used to supply power to and turn on the 1W LED modules.

Available in 2700°K and 3000°K versions.

Dimmable and non-dimmable, optional cover.

## LAFRA COLLEZIONE

*Elenganza pura con innovazione stilistica. Lafra è una famiglia di prodotti che soddisfano i bisogni di luce, tecnologia ed estetica.*

*Il metallo, conduttore di corrente, disponibile nei colori rame, nickel nero e cromo, permette di alimentare e accendere i moduli led da 1 w. Disponibile 2700°K e 3000°K. Dimmerabile e non, coperture optional.*

## LAFRA COLLEZIONE

*Pure Eleganz mit stilistischer Innovation. Lafra ist eine Produktfamilie, die dem Wunsch nach Licht, Technologie und Ästhetik gerecht wird.*

*Das stromleitende Metall ist in den Farben Kupfer, Nickel schwarz, und Chrom erhältlich und dient zum Speisen und Einschalten der 1W Led-Module. Erhältlich mit 2700°K und 3000°K. Dimmerbar und nicht dimmerbar, Abdeckungen optional.*

## LAFRA COLECCIÓN

*Elegancia pura con innovación estilística. Lafra es una familia de productos que satisface las necesidades de luz, tecnología y aspecto estético.*

*El metal, conductor de corriente, disponible en los colores cobre, níquel negro y cromo, permite alimentar y encender los módulos led de 1 w. Disponible con temperaturas de color de 2700°k y 3000°k. De intensidad luminosa regulable y fija, coberturas opcionales.*

## КОЛЛЕКЦИЯ LAFRA

*Безупречная элегантность и обновленный дизайн. Lafra – это серия изделий, которые удовлетворяют потребности, связанные с освещением, технологиями и эстетикой. Токопроводящий металл цвета черного никеля, хрома или меди позволяет питать и включать светодиодные модули 1 Вт.*

*Имеются в наличии модели 2700°K и 3000°K. С диммером и без, крышки не входят в базовую комплектацию*

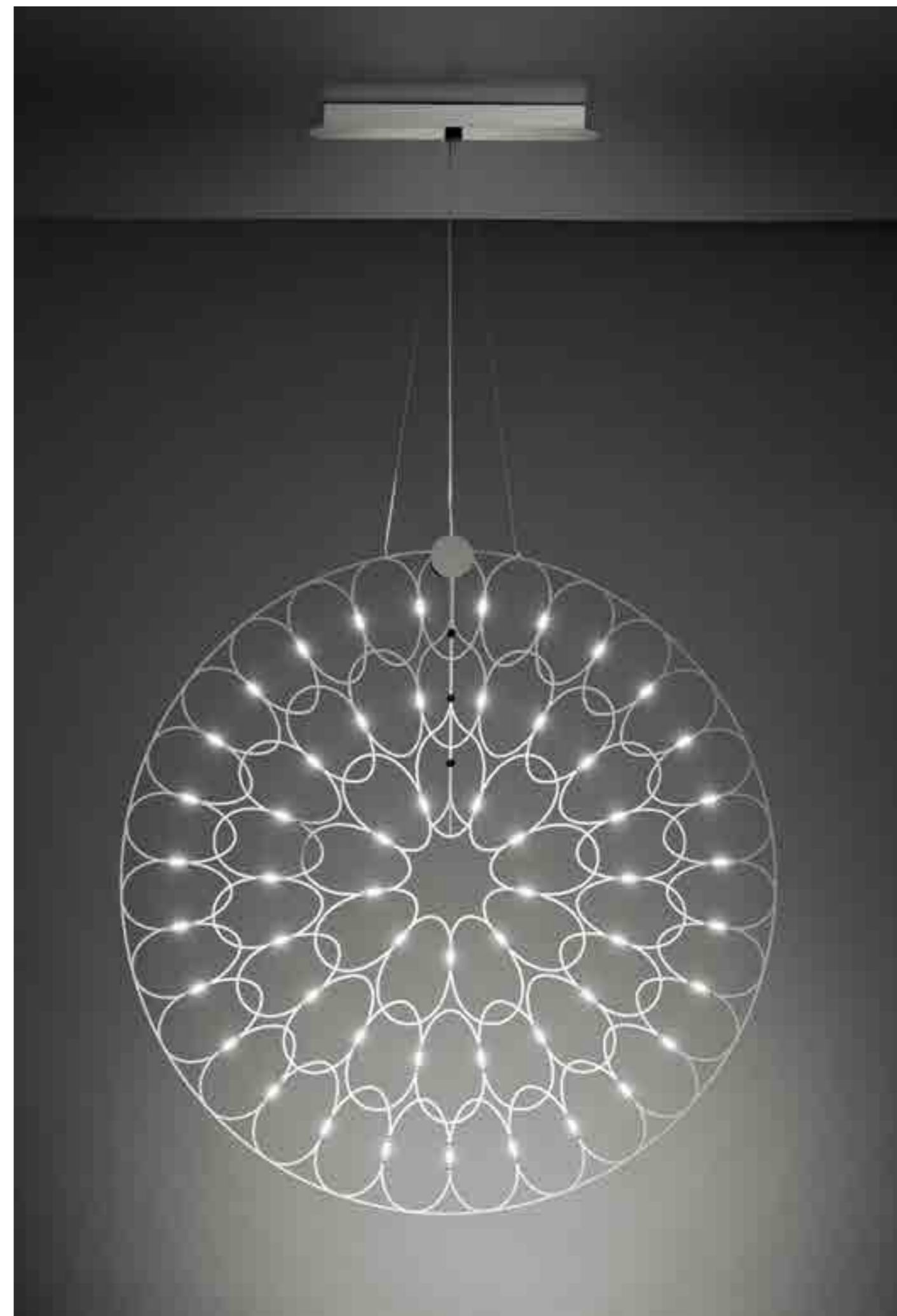

LAFRA VERTICAL SUSPENSION

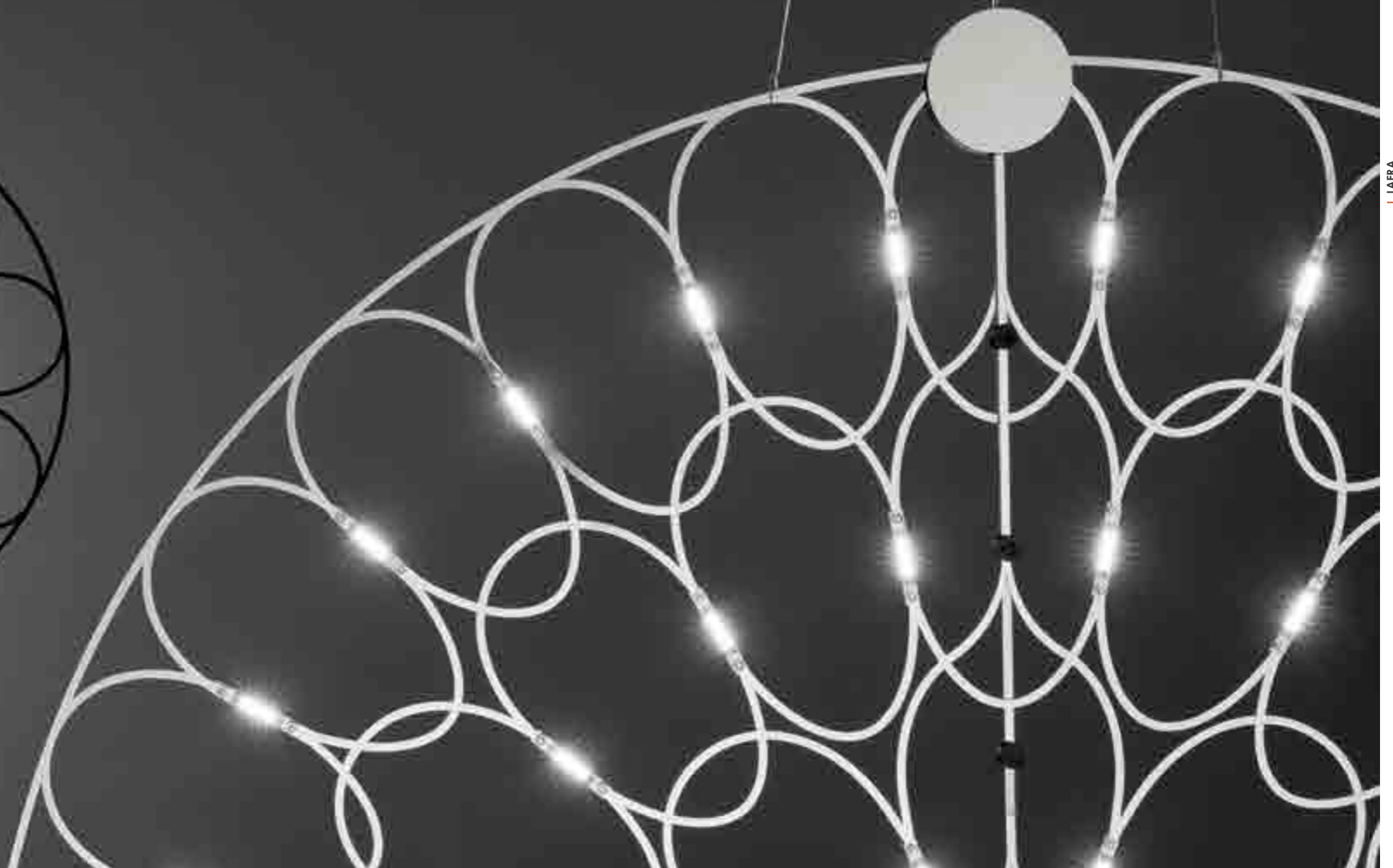

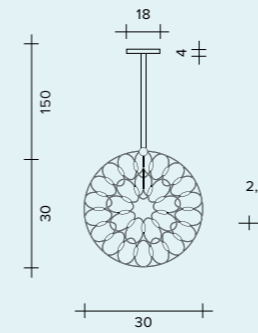

LED 7W - 24V  
2700°K / 525 lumen  
3000°K / 560 lumen

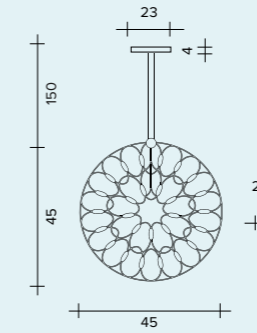

LED 9W - 24V  
2700°K / 675 lumen  
3000°K / 720 lumen

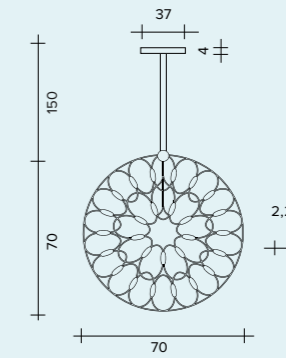

LED 27W - 24V  
2700°K / 2025 lumen  
3000°K / 2160 lumen

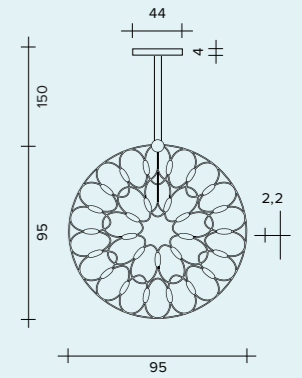

LED 54W - 24V  
2700°K / 4050 lumen  
3000°K / 4320 lumen

## LAFRA

### Vertical suspension

*Lampada a sospensione verticale*

*Vertikale pendelleuchte*

*Lámpara colgante vertical*

*Подвесная лампа вертикального типа*



### FINISHES / FINITURE / FARBE / ACABADOS / ОТДЕЛКИ

- Black / Nero / Schwarz / Negro / Чёрный цвет
- Chrome / Cromo / Chrom / Cromo / Хром
- Copper / Rame / Kupfe / Cobre / Медь

LAFRA HORIZONTAL SUSPENSION

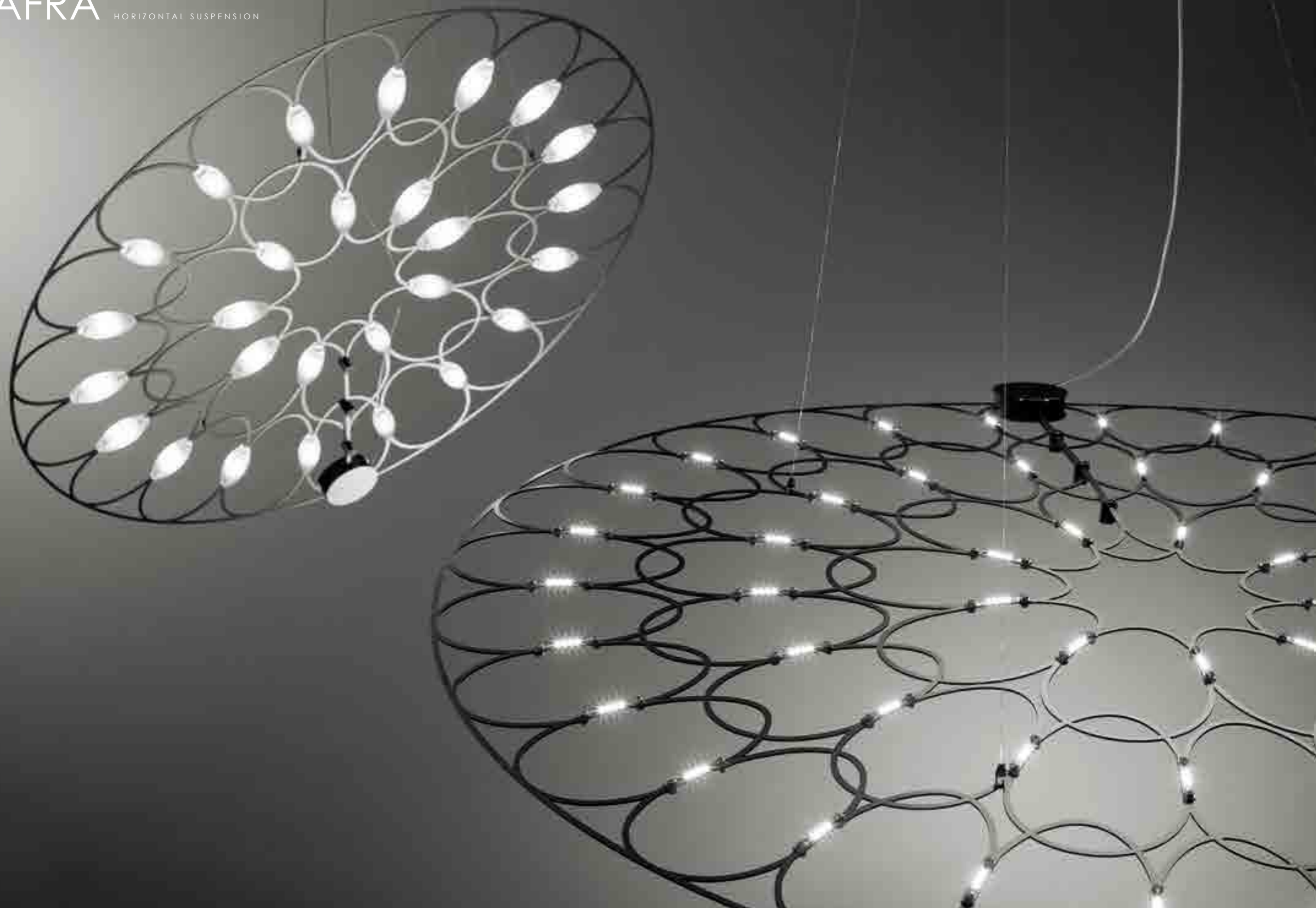

# LAFRA

HORIZONTAL SUSPENSION





# LAFRA

HORIZONTAL SUSPENSION

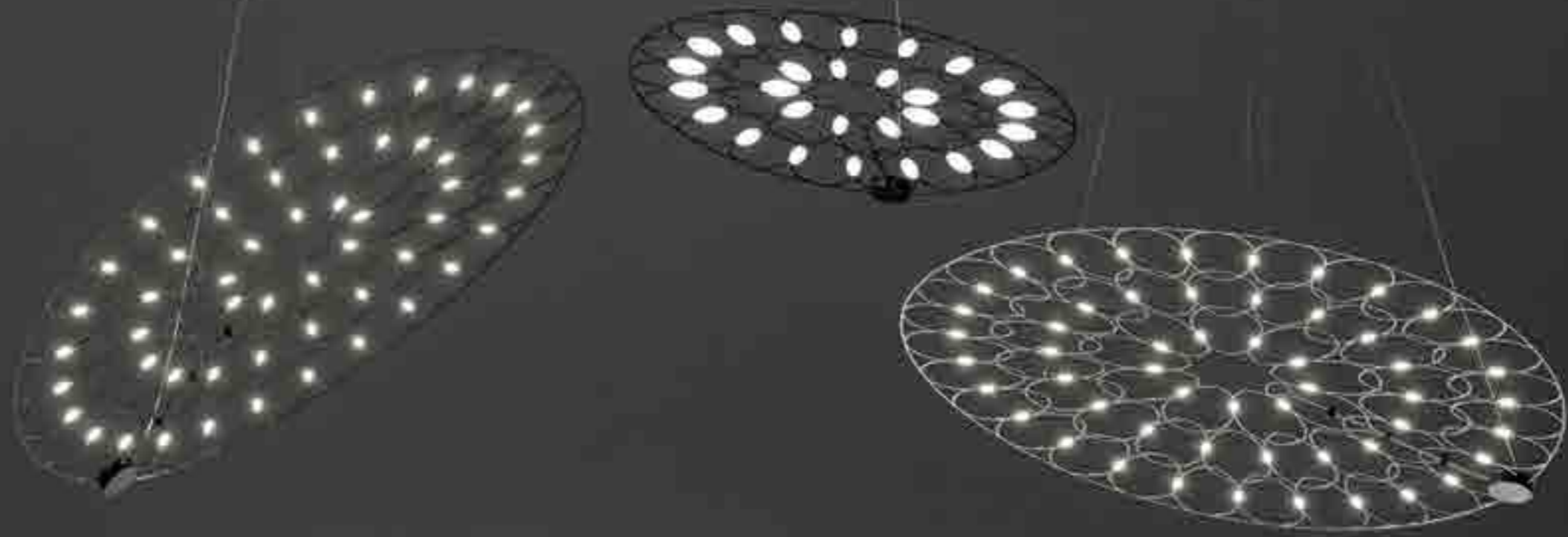

# LAFRA

HORIZONTAL SUSPENSION

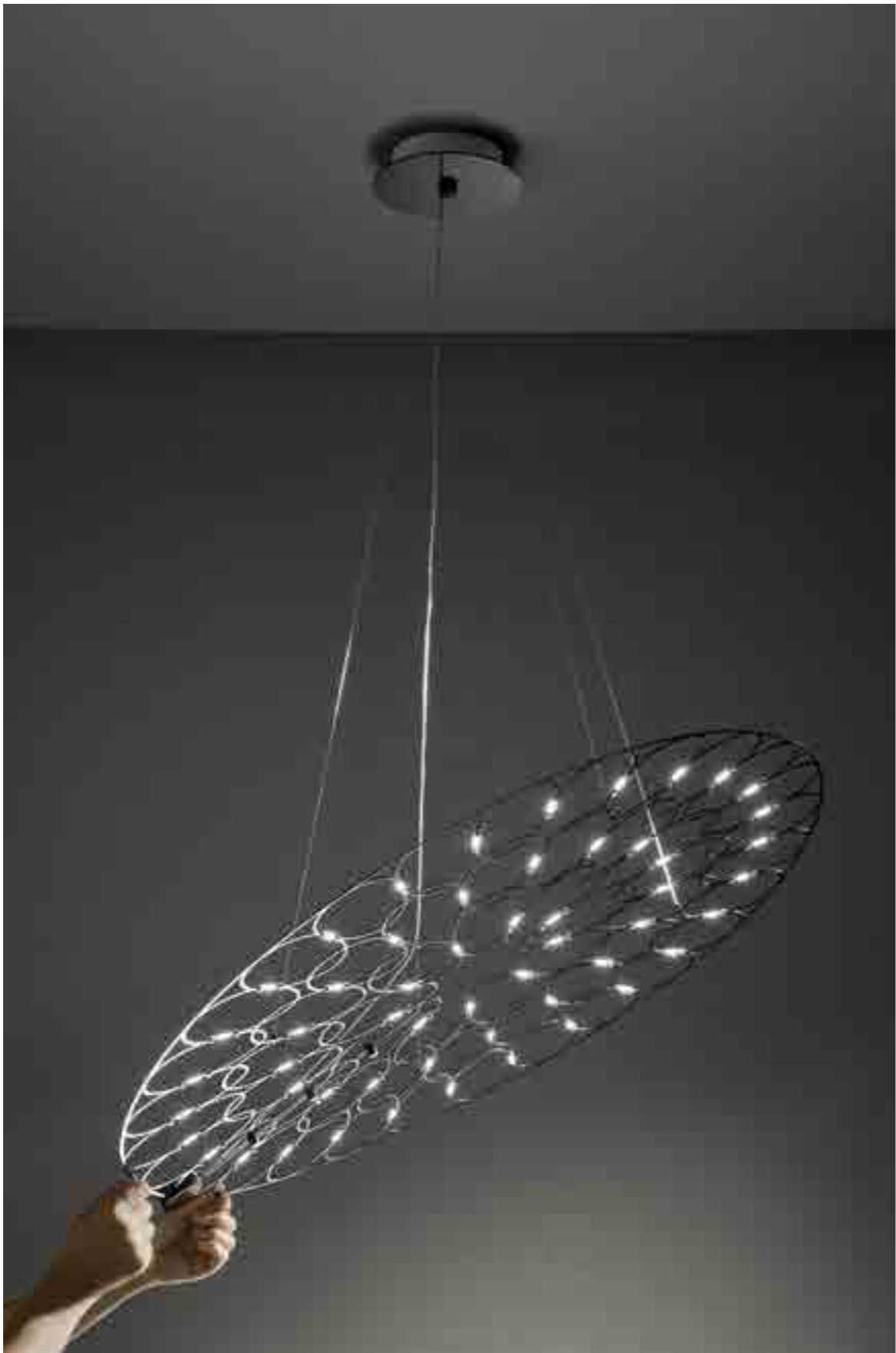

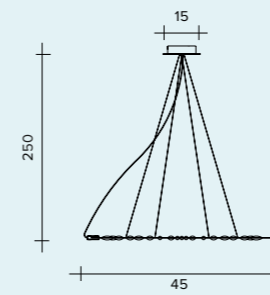
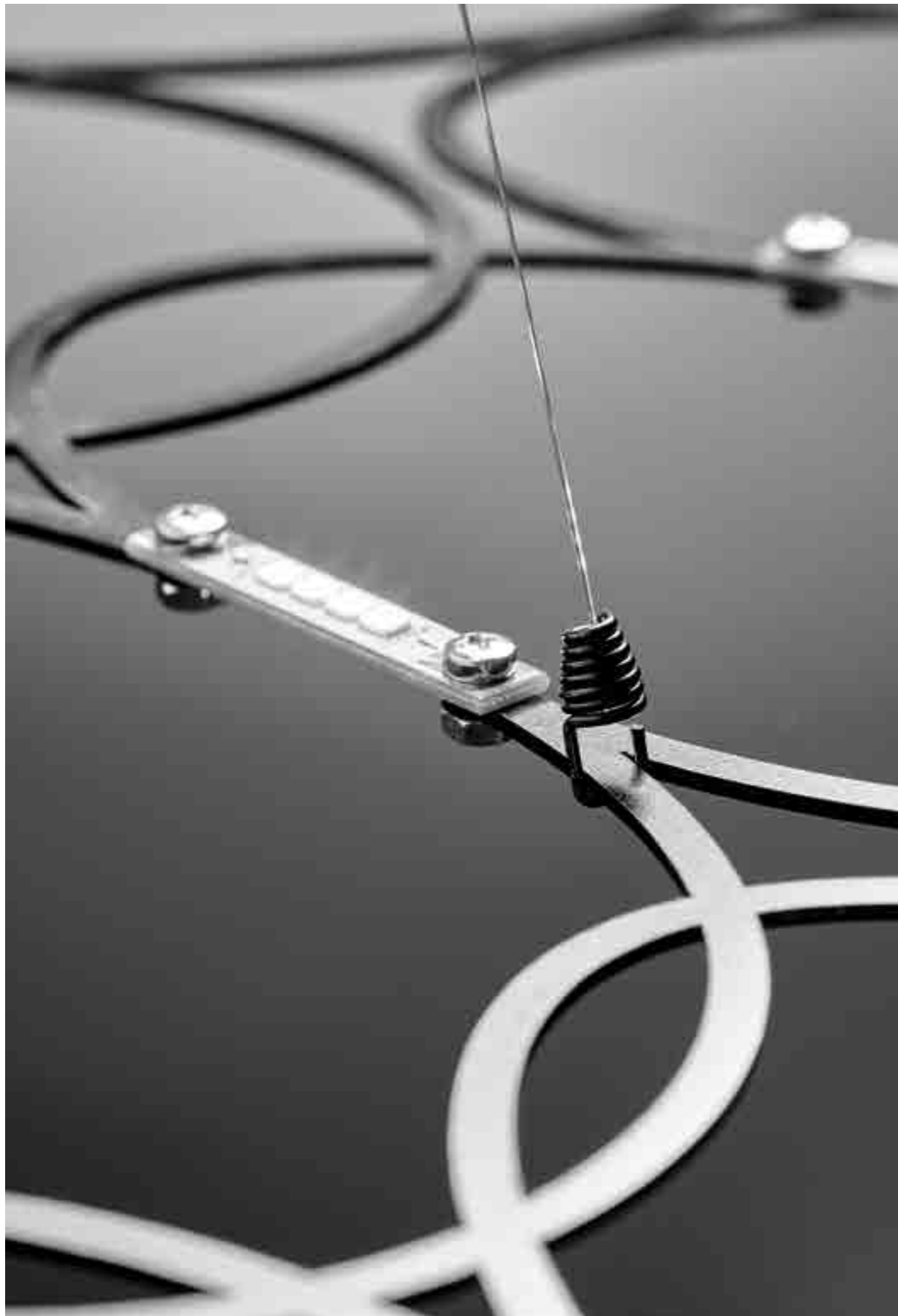

LED 9W - 24V  
2700°K / 675 lumen  
3000°K / 720 lumen

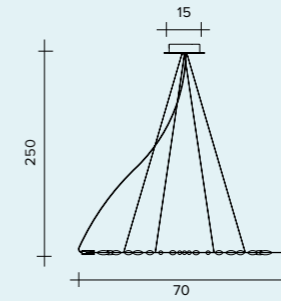

LED 27W - 24V  
2700°K / 2052 lumen  
3000°K / 2160 lumen

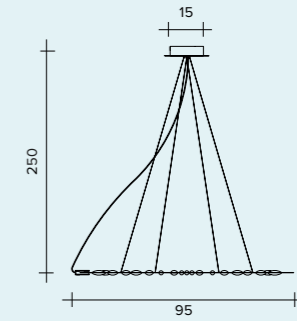

LED 54W - 24V  
2700°K / 4050 lumen  
3000°K / 4320 lumen

## LAFRA

### Horizontal suspension

*Lampada a sospensione orizzontale*

*Horizontale pendelleuchte*

*Lámpara colgante horizontal*

*Подвесная лампа горизонтального типа*



### FINISHES / FINITURE / FARBE / ACABADOS / ОТДЕЛКИ

- Black / Nero / Schwarz / Negro / Чёрный цвет
- Chrome / Cromo / Chrom / Cromo / Хром
- Copper / Rame / Kupfe / Cobre / Медь

LAFRA CEILING





# LAFRA CEILING



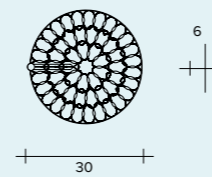

LED 7W - 24V  
2700°K / 525 lumen  
3000°K / 560 lumen

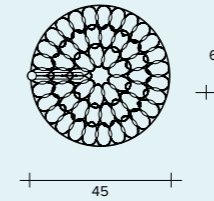

LED 9W - 24V  
2700°K / 675 lumen  
3000°K / 720 lumen

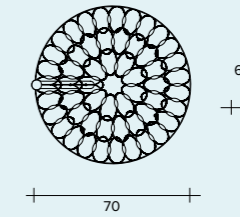

LED 27W - 24V  
2700°K / 2052 lumen  
3000°K / 2160 lumen

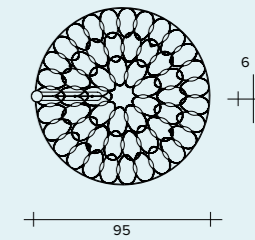

LED 54W - 24V  
2700°K / 4050 lumen  
3000°K / 4320 lumen

## LAFRA Ceiling

Lampada da soffitto  
Deckenleuchte  
Lámpara de techo  
Потолочная лампа



### FINISHES / FINITURE / FARBE / ACABADOS / ОТДЕЛКИ

- Black / Nero / Schwarz / Negro / Чёрный цвет
- Chrome / Cromo / Chrom / Cromo / Хром
- Copper / Rame / Kupfe / Cobre / Медь

LAFRA WALL

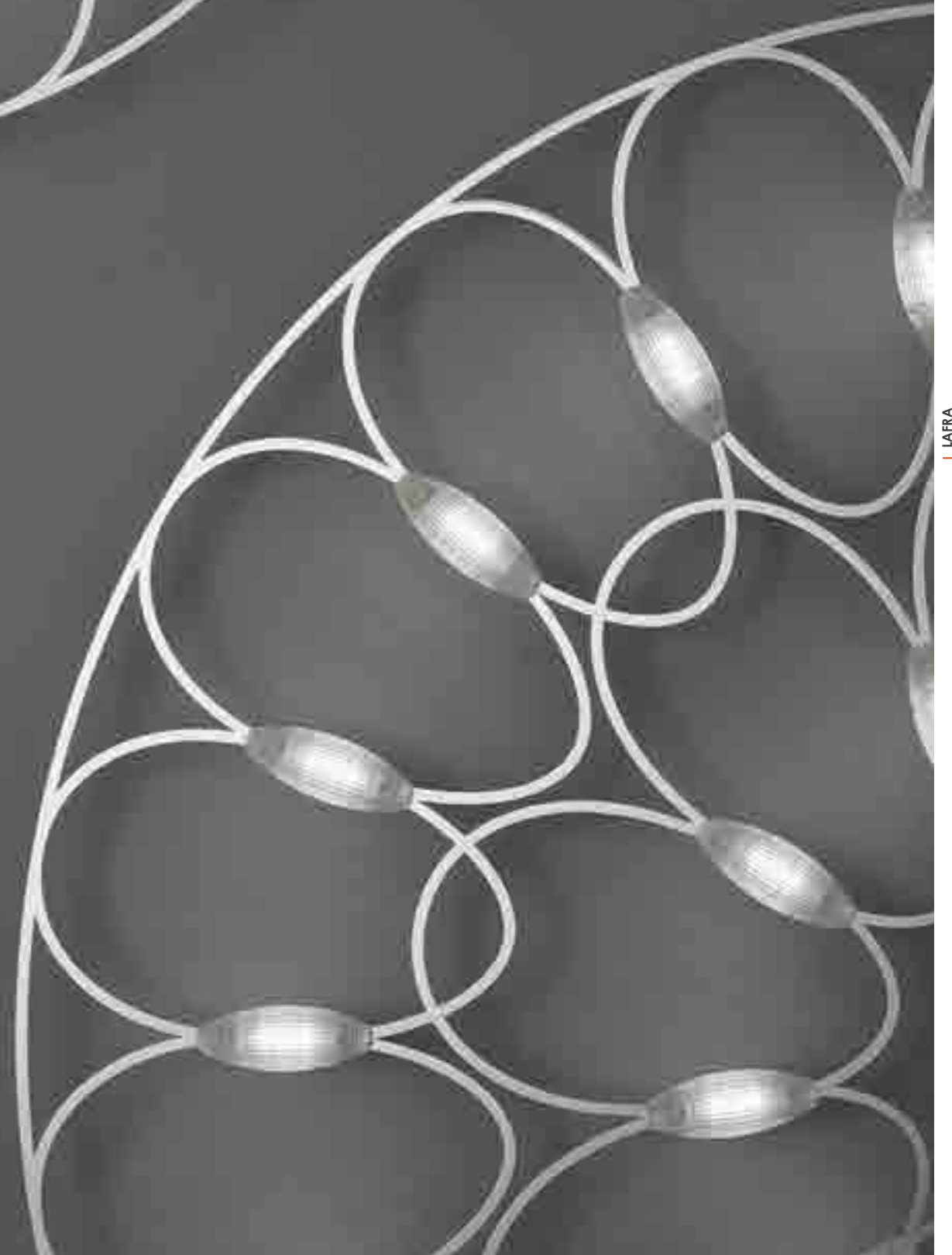
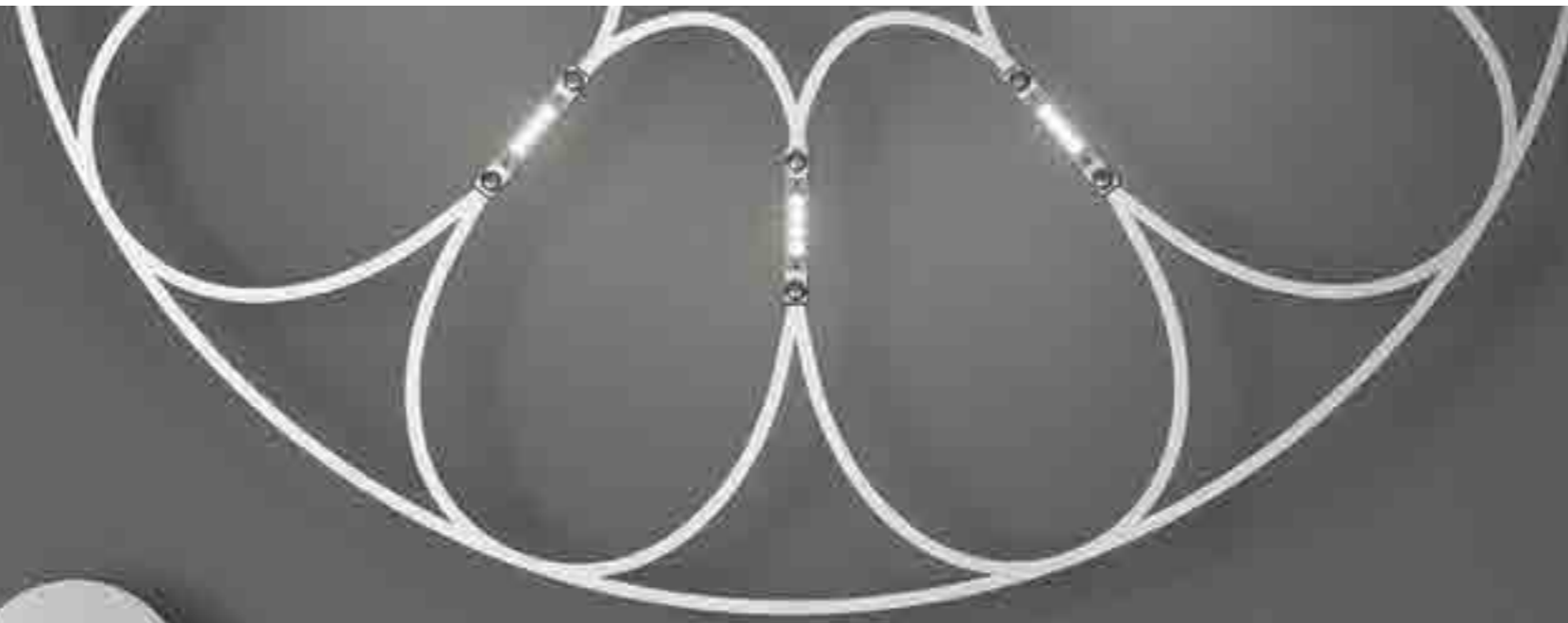
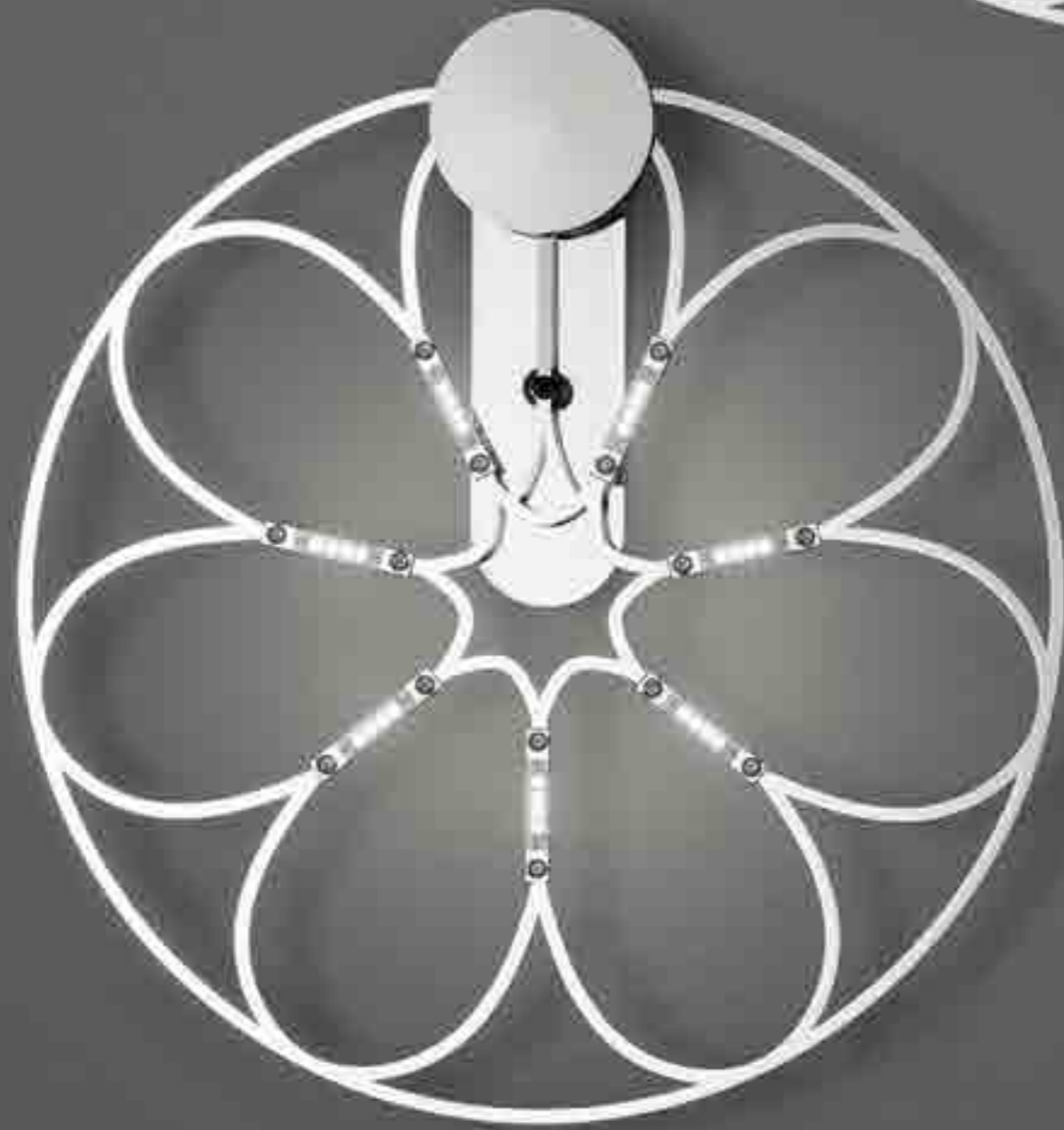

# LAFRA WALL



LAFRA



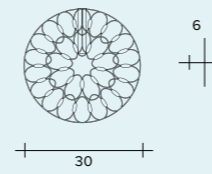

LED 7W - 24V  
2700°K / 525 lumen  
3000°K / 560 lumen

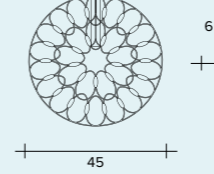

LED 9W - 24V  
2700°K / 675 lumen  
3000°K / 720 lumen

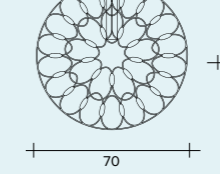

LED 27W - 24V  
2700°K / 2052 lumen  
3000°K / 2160 lumen

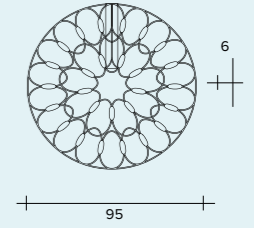

LED 54W - 24V  
2700°K / 4050 lumen  
3000°K / 4320 lumen

## LAFRA Wall

Lampada da parete  
Wandleuchte  
Lámpara de pared  
Настенная лампа



### FINISHES / FINITURE / FARBE / ACABADOS / ОТДЕЛКИ

- Black / Nero / Schwarz / Negro / Чёрный цвет
- Chrome / Cromo / Chrom / Cromo / Хром
- Copper / Rame / Kupfe / Cobre / Медь

# CAOS CONTRACT

design Studio O.I.L.

## CAOS CONTRACT COLLECTION

Poetic lines and clean curves create light and harmonious lamps with a black and gold finish and dimmable LEDs controlled by a phase cut dimmer switch. The 220V module supplies power to the lamps to meet every need with regard to appearance and function.



reddot award 2018  
honourable mention

## CAOS CONTRACT COLLEZIONE

Linea poetica, curve pulite disegnano lampade leggere ed armoniose in colore nero e oro, i led sono dimmerabili con dimmer a taglio di fase. Con il modulo a 220v si ha la possibilità di alimentare le lampade per ogni esigenza: estetica e funzionale.

## CAOS CONTRACT KOLLEKTION

Poetische Linie und saubere Kurven, die leichten und harmonischen Leuchten sind in Schwarz und goldfarben erhältlich; LED mit Phasenabschnittsdimmer dimmerbar. Mit dem 220V Modul kann man die Leuchten für jeden Bedarf speisen: ästhetisch und praktisch.

## CAOS CONTRACT COLECCIÓN

Línea poética y curvas limpias diseñan lámparas ligeras y armoniosas, en color negro y oro, la intensidad luminosa de los ledes es regulable con regulador de corte de fase. Con el módulo de 220 V es posible alimentar las lámparas para cada exigencia: estética y funcional.

## КОЛЛЕКЦИЯ CAOS CONTRACT

Поэтичная линия, аккуратные изгибы отличают дизайн легких и гармоничных ламп черного и золотого цвета; регулировка силы света светодиодов выполняется диммером с отсечкой фазы. Модуль 220В дает возможность питать лампы в зависимости от любых эстетических или функциональных потребностей.





# CAOS CONTRACT

CEILING

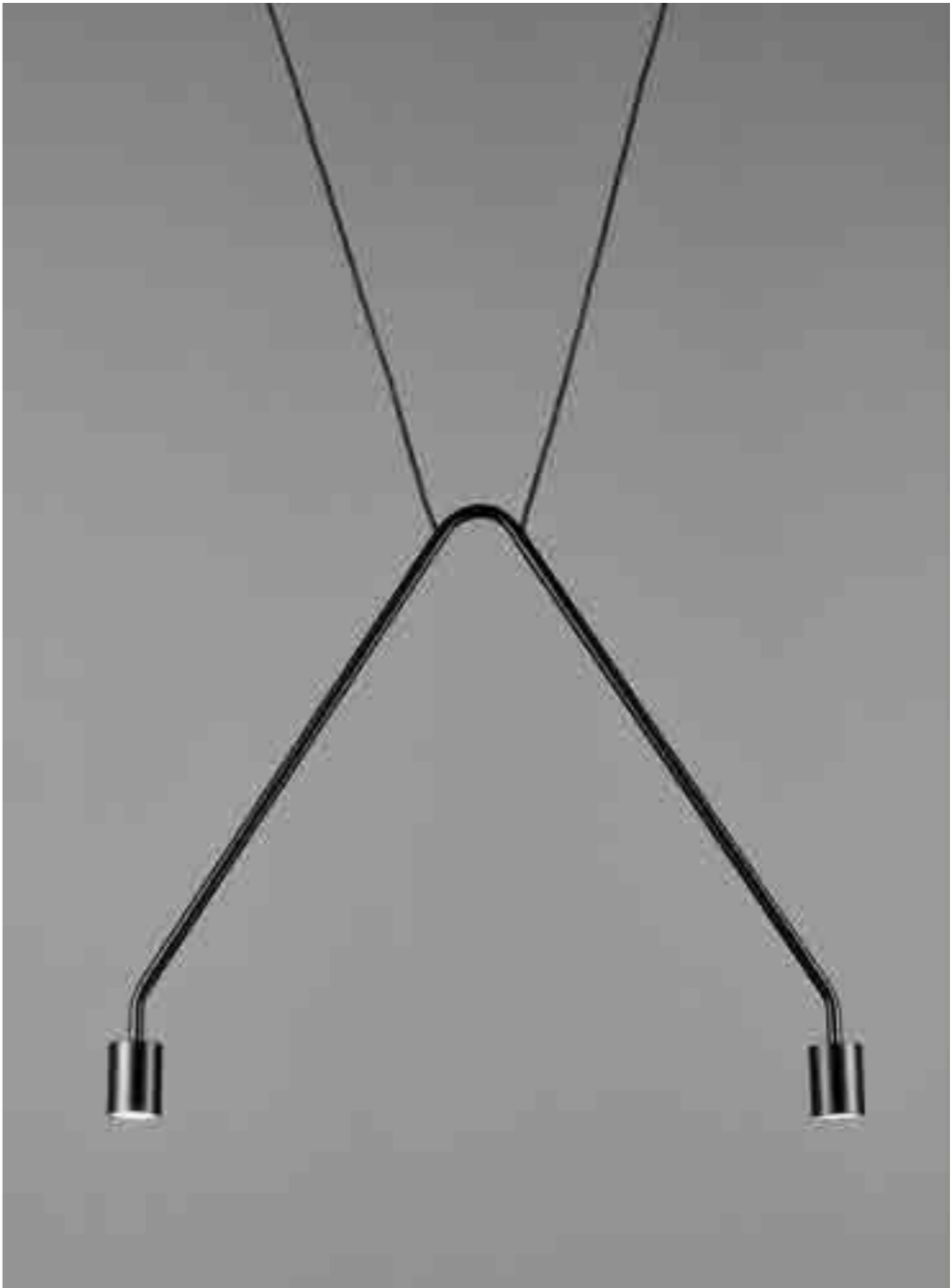

# CAOS CONTRACT

CEILING

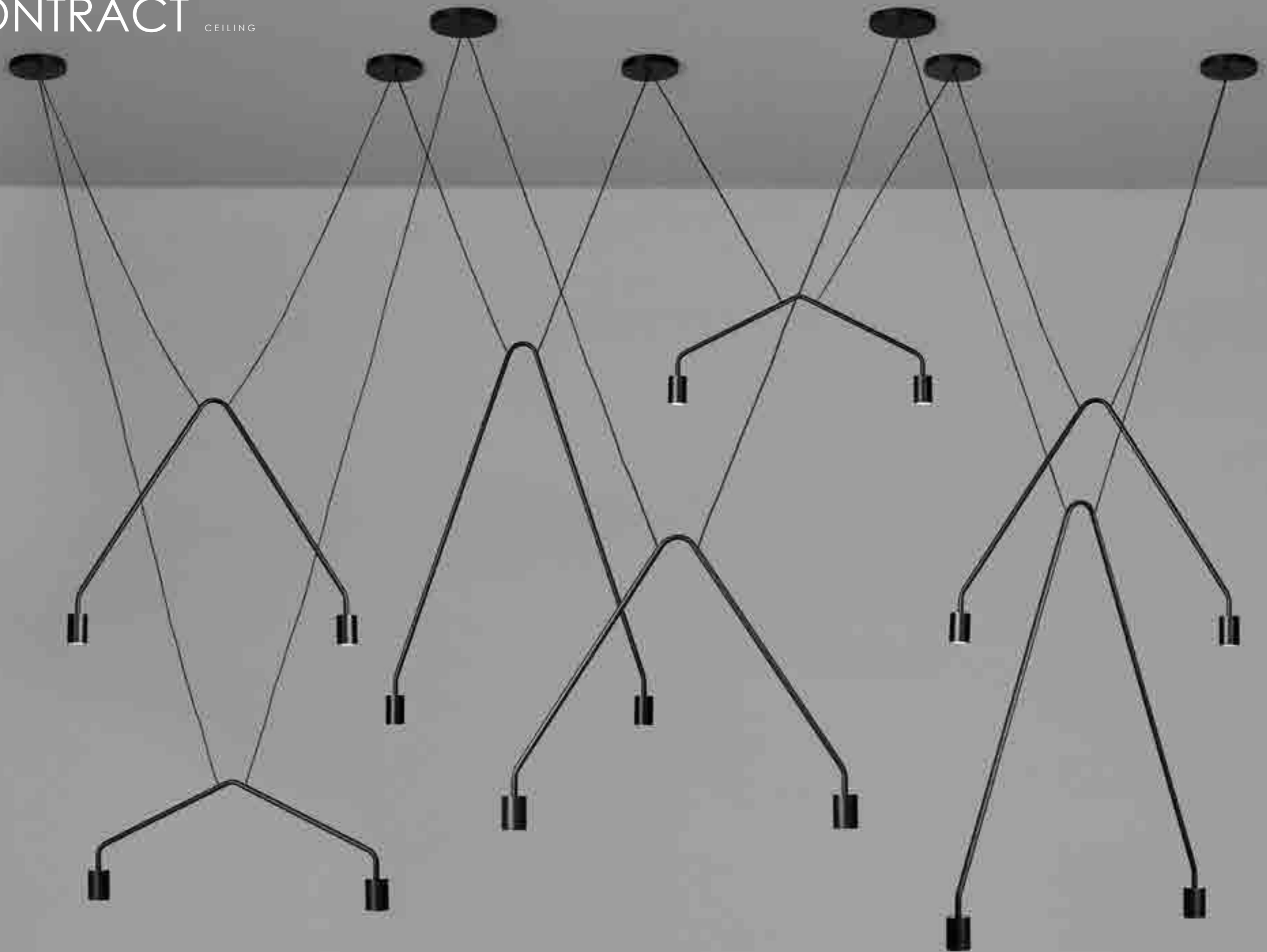

# CAOS CONTRACT

CEILING

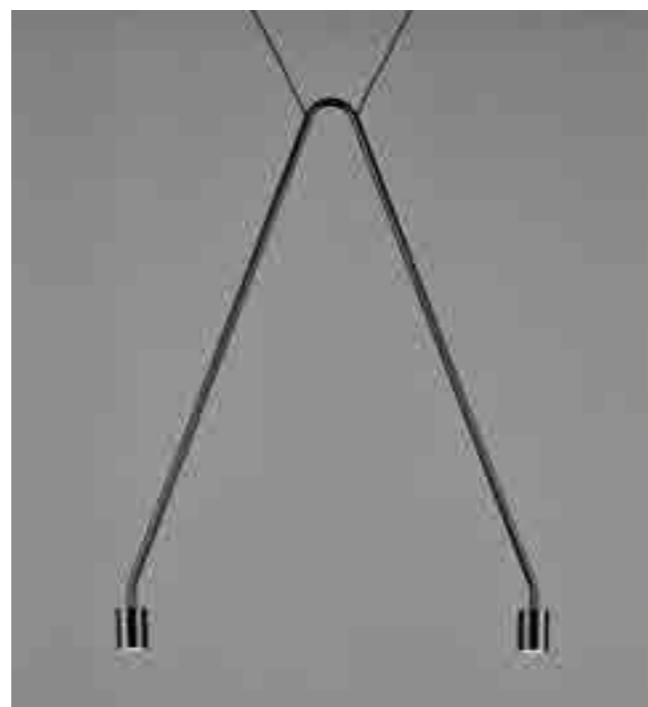

# CAOS CONTRACT

SUSPENSION  
GOLD EDITION



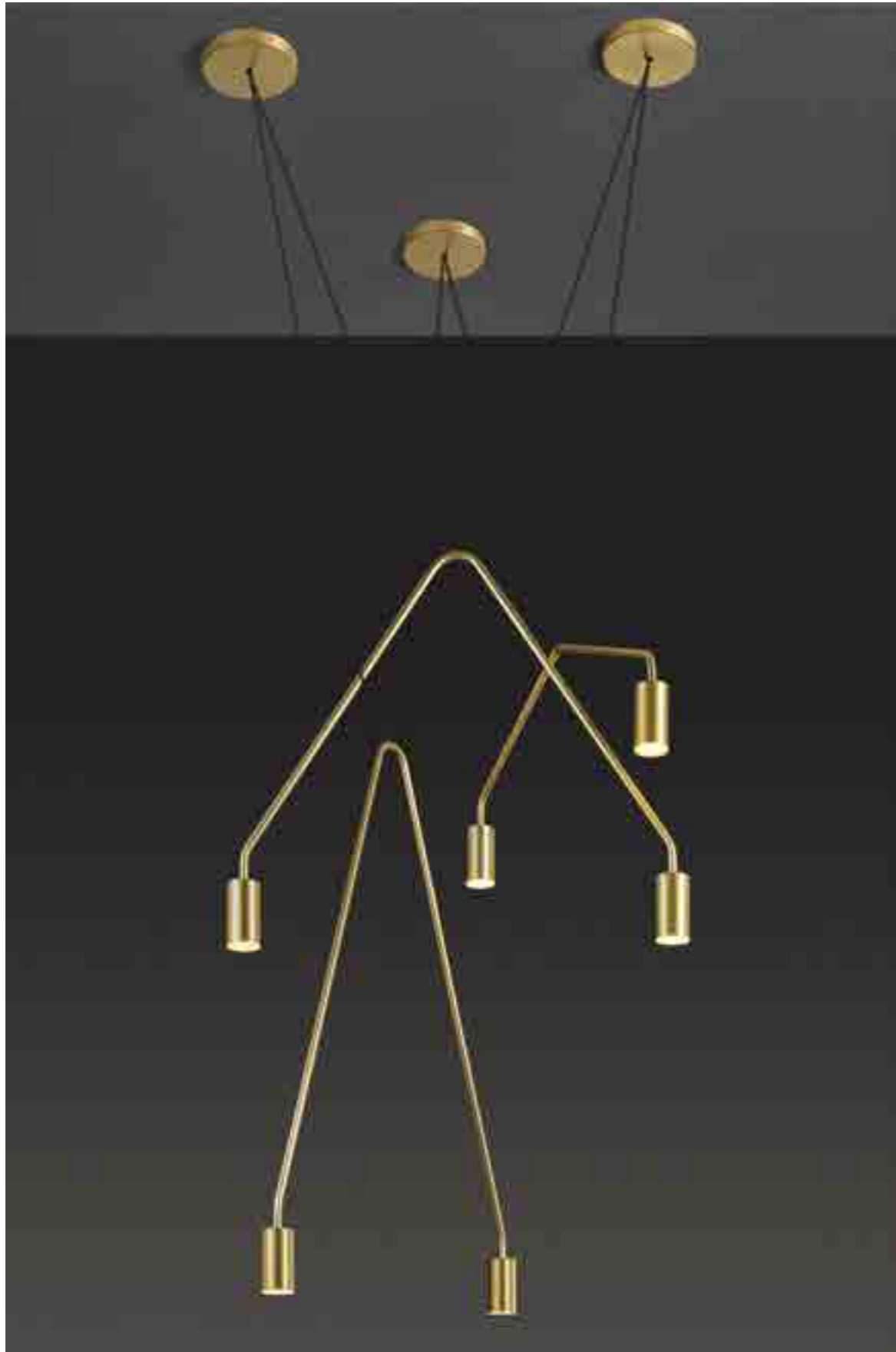

# CAOS CONTRACT

SUSPENSION  
GOLD EDITION



# CAOS CONTRACT

SUSPENSION  
GOLD EDITION

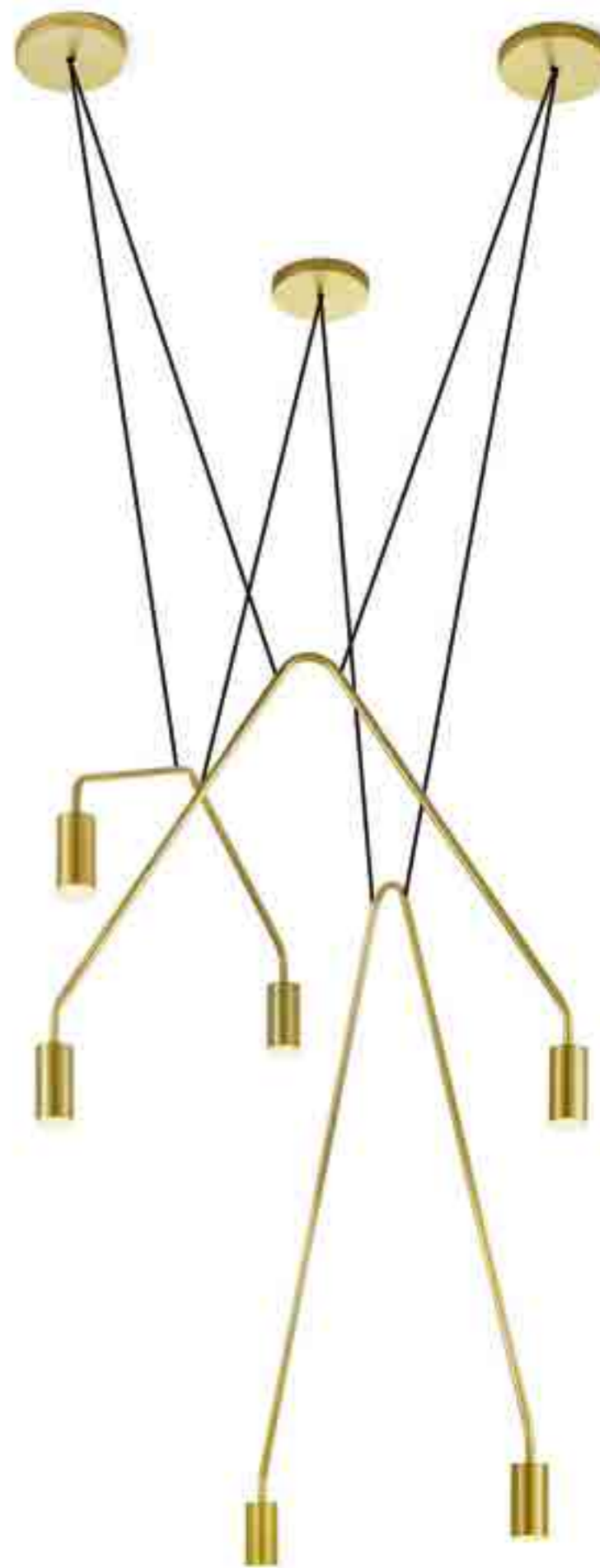
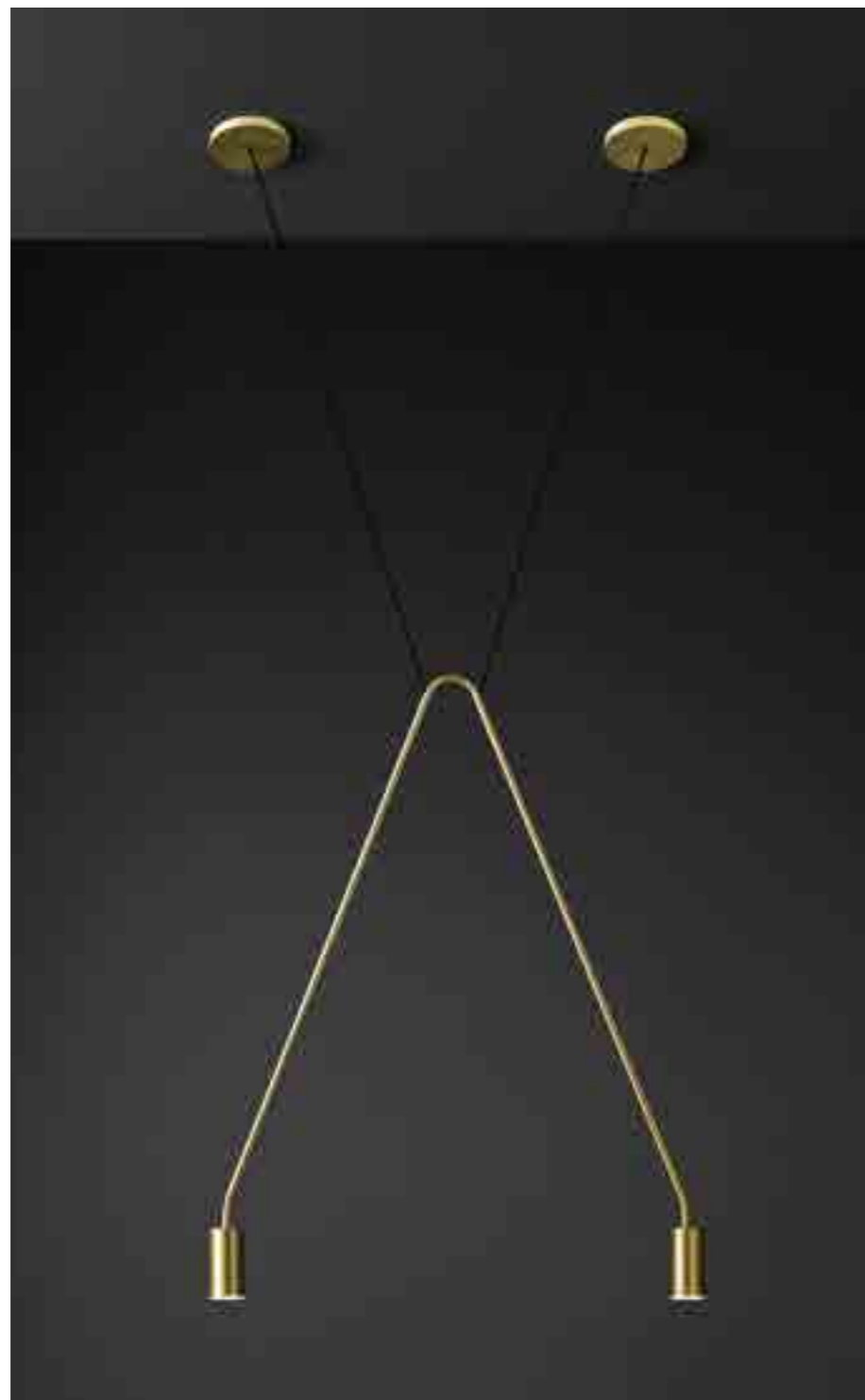



# CAOS CONTRACT

MODULAR SYSTEM

This modular system is available in three sizes: small, medium, large. The system can be connected to the power supply from any rosette. The drawings illustrate installation examples.

*Il sistema è componibile nelle tre dimensioni: piccola, media, grande. Partendo da qualsiasi rosette il sistema viene elettrificato. Nei disegni sono indicati degli esempi di installazione.*

*Das System ist in den drei Größen zusammenstellbar: klein, mittelgroß, groß. Das System wird von einer beliebigen Rosette ausgehend elektrifiziert. In den Zeichnungen sind Installationsbeispiele aufgeführt.*

*El sistema es componible en las tres dimensiones: pequeña, mediana, grande. Partiendo de cualquier rosetón se electrifica el sistema. En los dibujos se presentan unos ejemplos de instalación.*

*Систему можно выполнять в трех вариантах по размерам: маленький размер, средний размер, большой размер. Система электрифицируется, независимо от вида диска. На рисунках приведены примеры монтажа.*

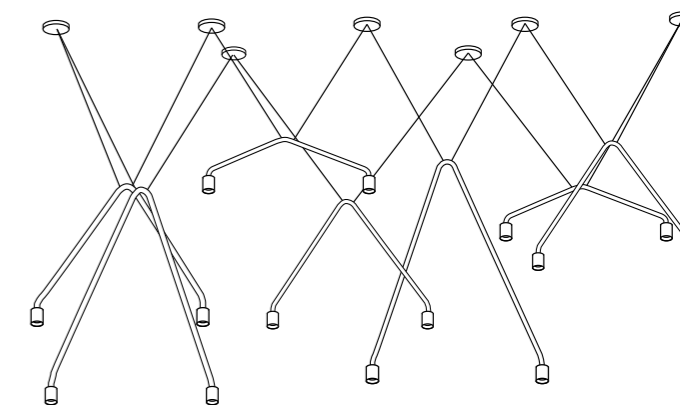
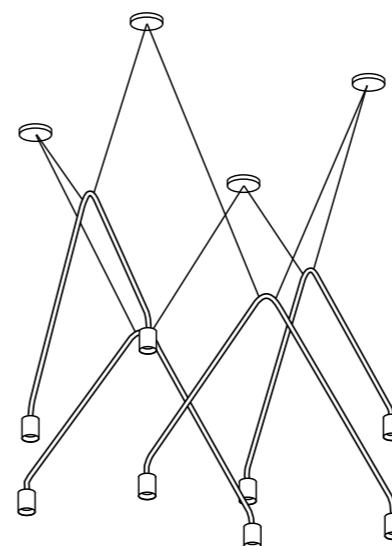
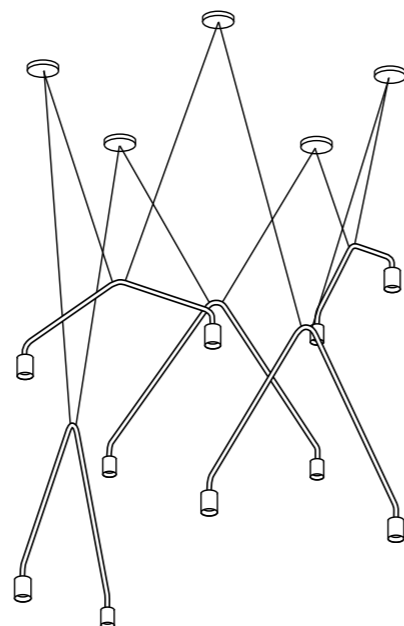
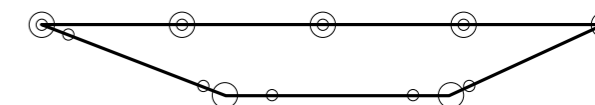
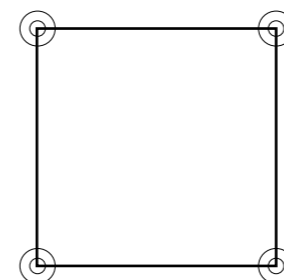
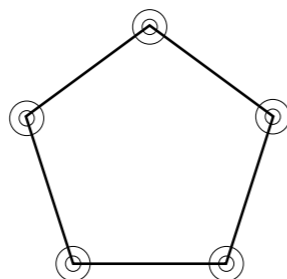
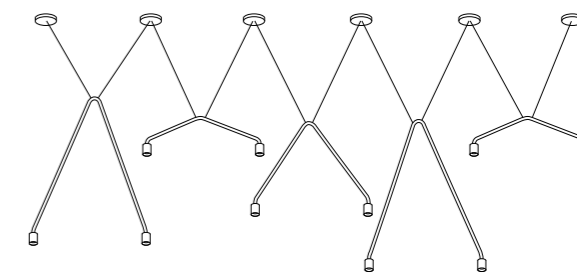
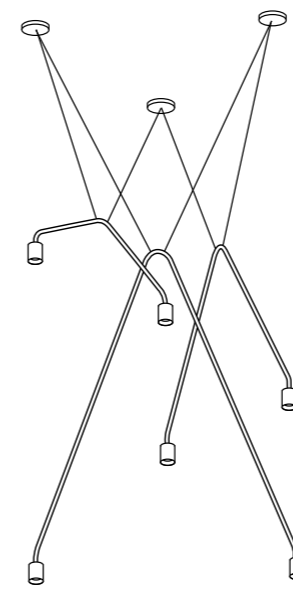
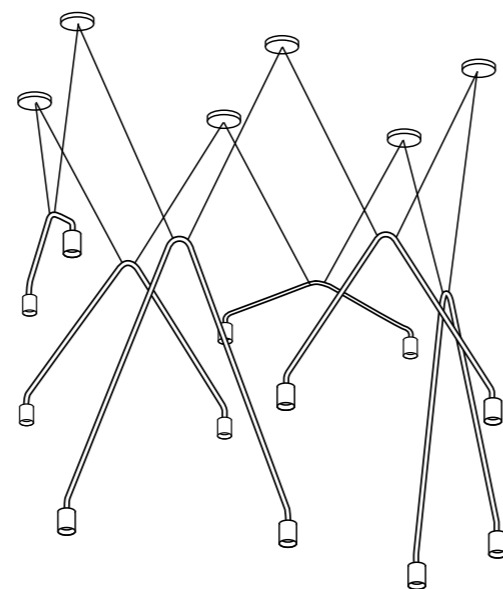
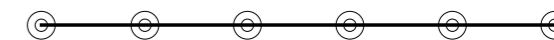
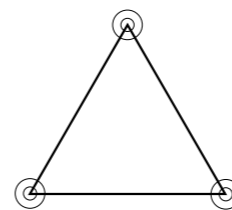
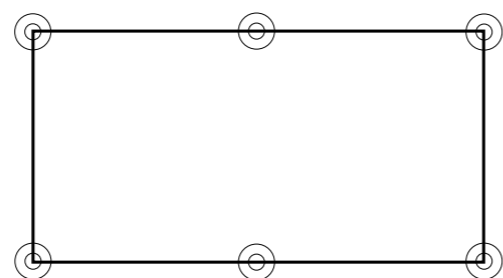

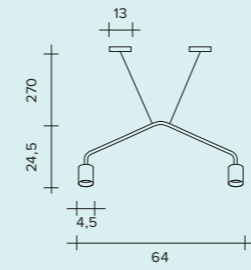

2 x G9 LED max 6w

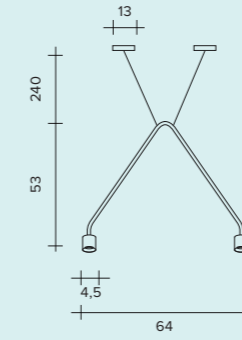

2 x G9 LED max 6w

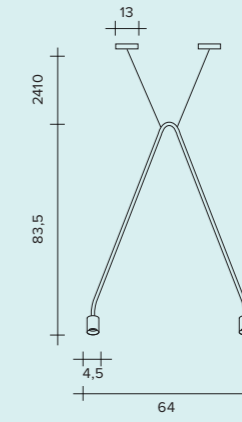

2 x G9 LED max 6w

## CAOS CONTRACT Ceiling

Lampada da soffitto  
Deckenleuchte  
Lámpara de techo  
Потолочная лампа



### FINISHES / FINITURE / FARBE / ACABADOS / ОТДЕЛКИ

- Black / Nero / Schwarz / Negro / Чёрный цвет
- Brushed gold / Oro spazzolato / Gold gebürstet  
Oro cepillado / Брашированное золото

# CAOS

design Studio O.I.L.

## CAOS COLLECTION

Poetic lines and clean curves create light and harmonious lamps with a black and gold finish and dimmable LEDS controlled by a phase cut dimmer switch.



reddot award 2018  
honourable mention

## CAOS COLLEZIONE

*Linea poetica, curve pulite  
disegnano lampade leggere  
ed armoniose in colore nero e oro,  
i led sono dimmerabili con dimmer  
a taglio di fase.*

## CAOS KOLLEKTION

*Poetische Linie und saubere Kurven,  
die leichten und harmonischen  
Leuchten sind in Schwarz und  
goldfarben erhältlich; LED mit  
Phasenabschnittsdimmer  
dimmerbar.*

## CAOS COLECCIÓN

*Línea poética y curvas limpias  
diseñan lámparas ligeras y  
armoniosas, en color negro y oro,  
la intensidad luminosa de  
los ledes es regulable con  
regulador de corte de fase.*

## КОЛЛЕКЦИЯ CAOS

*Поэтичная линия, аккуратные  
изгибы отличают дизайн легких  
и гармоничных ламп черного и  
золотого цвета; регулировка  
света светодиодов выполняется  
диммером с отсечкой фазы.*



# CAOS SUSPENSION



CAOS SUSPENSION  
GOLD EDITION

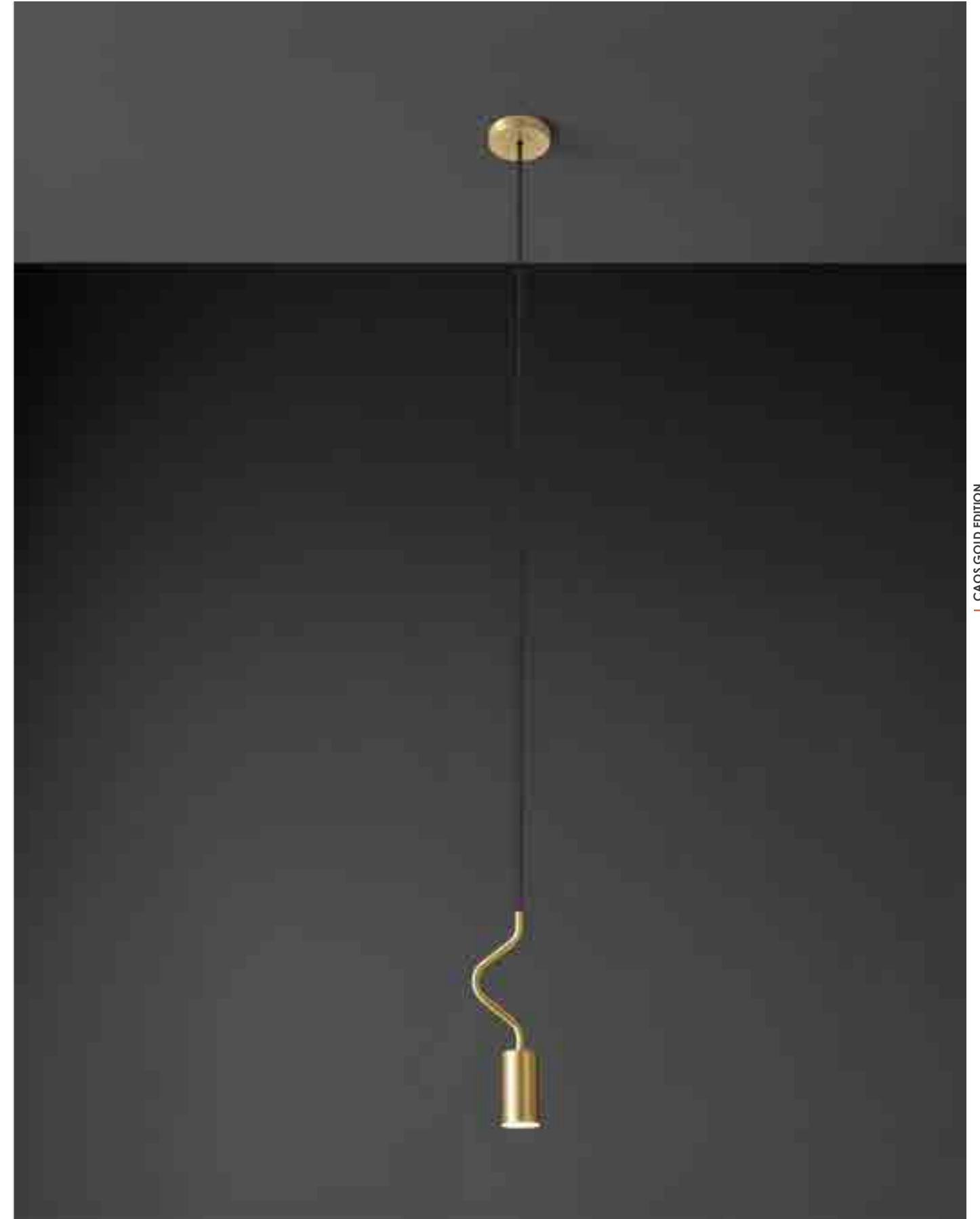
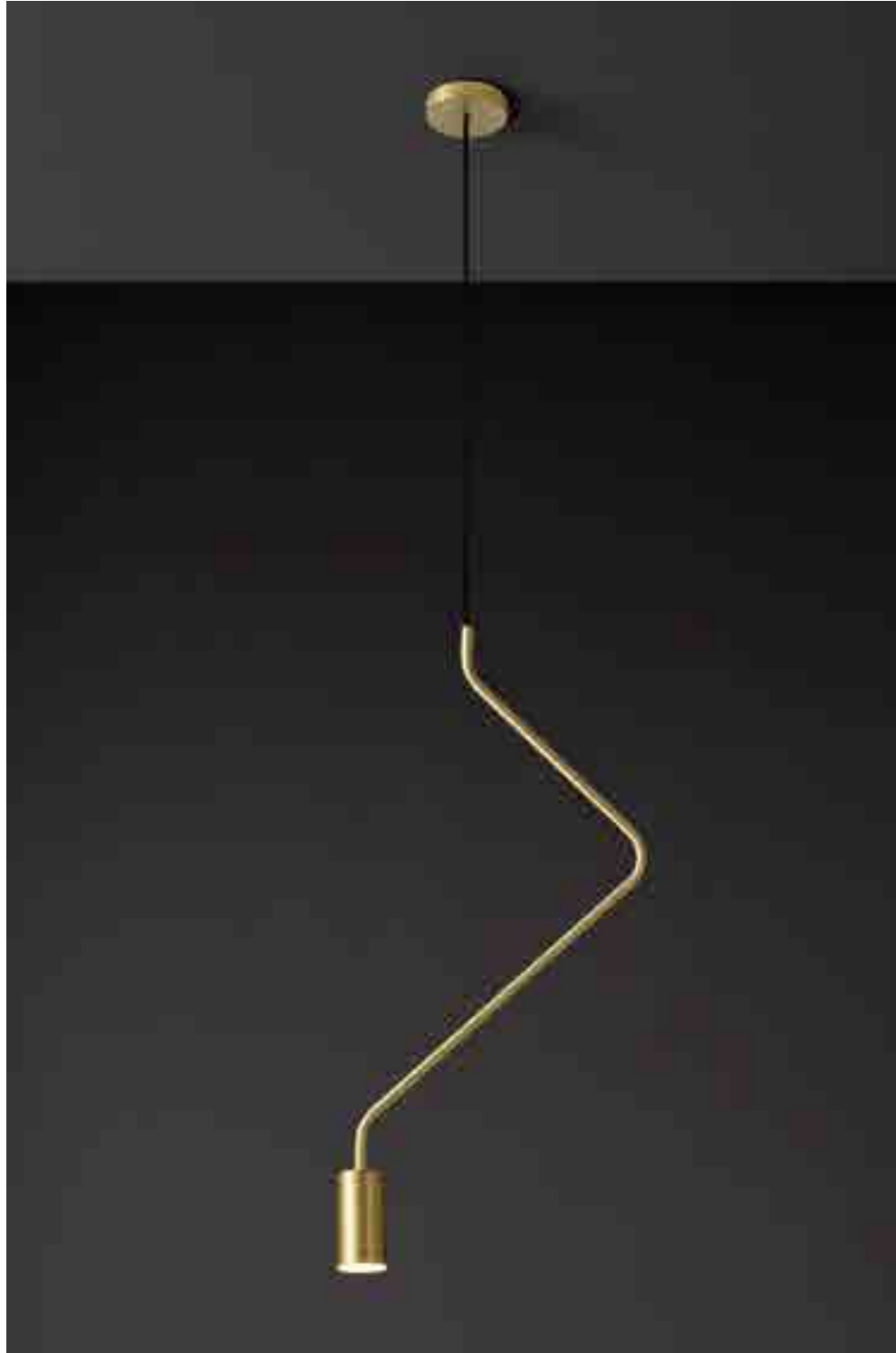

| CAOS GOLD EDITION



CAOS SUSPENSION  
GOLD EDITION

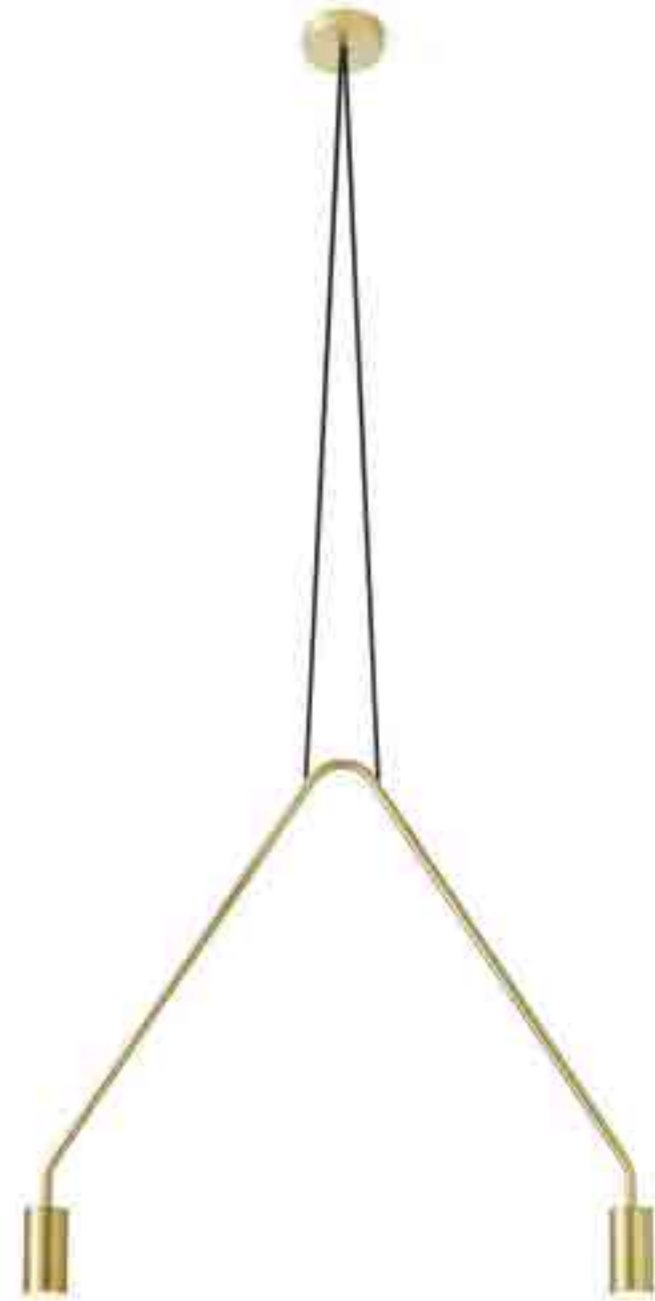

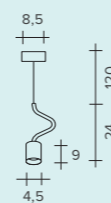

1 x G9 LED max 6w

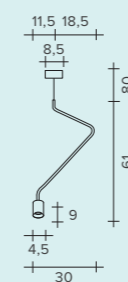

1 x G9 LED max 6w

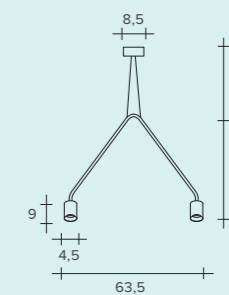

2 x G9 LED max 6w

## CAOS Suspension

Lampada a sospensione  
Pendelleuchte  
Lámpara colgante  
Подвесная лампа



### FINISHES / FINITURE / FARBE / ACABADOS / ОТДЕЛКИ

- Black / Nero / Schwarz / Negro / Чёрный цвет
- Brushed gold / Oro spazzolato / Gold gebürstet  
Oro serillado / Брашированное золото



CAOS CEILING  
GOLD EDITION





# CAOS CEILING



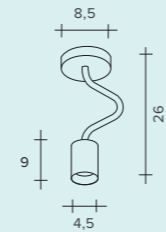
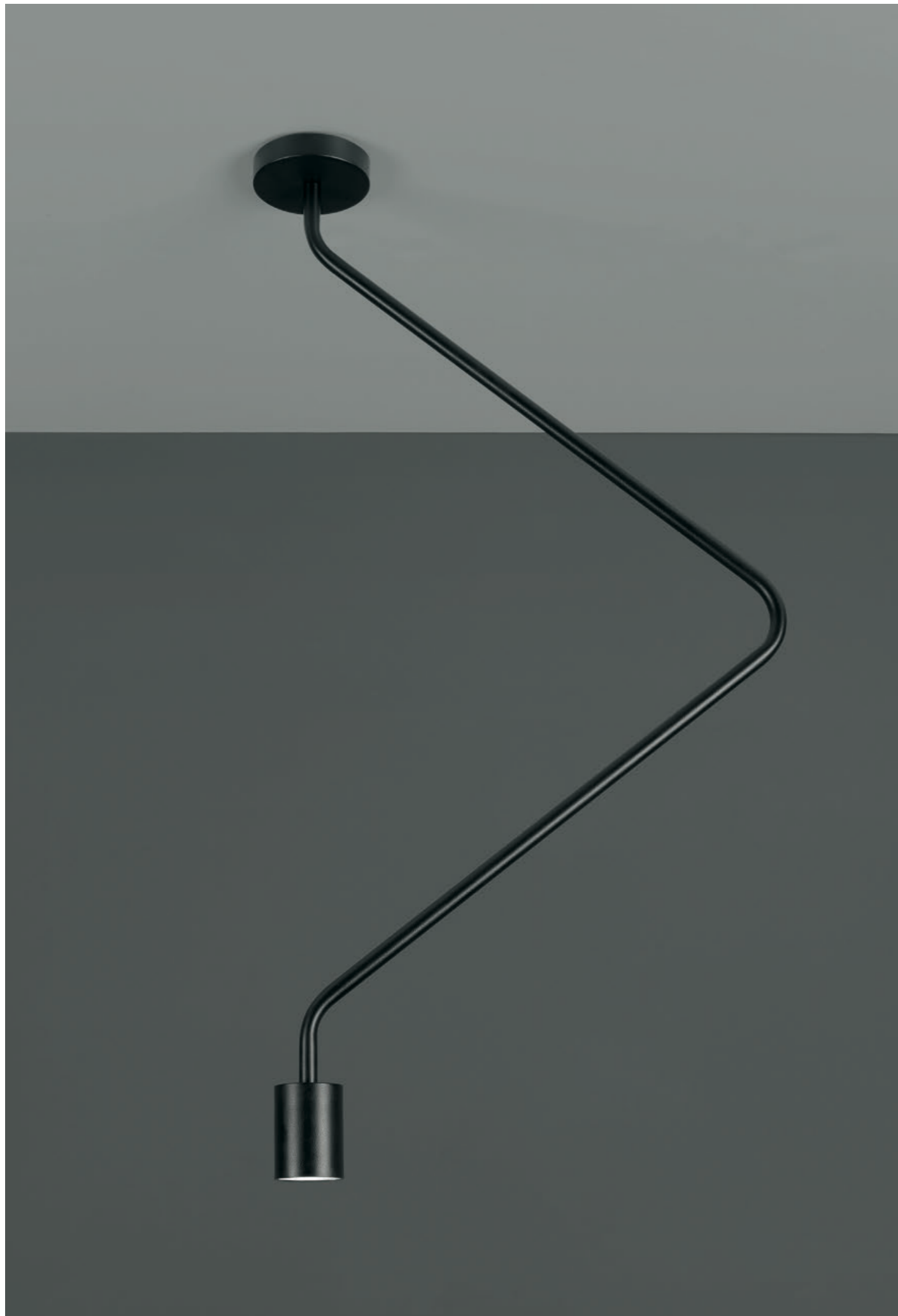

1 x G9 LED max 6w

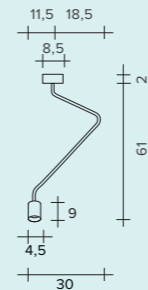

1 x G9 LED max 6w

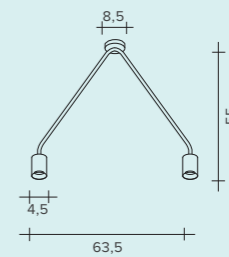

2 x G9 LED max 6w

## CAOS Ceiling

Lampada da soffitto  
Deckenleuchte  
Lámpara de techo  
Потолочная лампа



### FINISHES / FINITURE / FARBE / ACABADOS / ОТДЕЛКИ

- Black / Nero / Schwarz / Negro / Чёрный цвет
- Brushed gold / Oro spazzolato / Gold gebürstet  
Oro cepillado / Брашированное золото

# AREA

design Marco Spatti

## AREA COLLECTION

Clean lines, simple geometric forms. Area is the ultimate expression of elegance and linearity. Available in matt black or aluminium colours. A frosted shade and 3000°K LED strip create a comfortable and warm environment.

## AREA COLLEZIONE

*Linee pulite, geometriche essenziali. Area è la massima espressione di eleganza e linearità. In colore nero opaco ed alluminio. Copertura satinata e striscia a led di 3000°K rendono l'ambiente confortevole e caldo.*

## AREA KOLLEKTION

*Saubere, geometrische, essentielle Linien. Area ist Ausdruck maximaler Eleganz und Linearität. In den Farben Mattschwarz und Aluminium. Die seidenmatte Abdeckung und der Led-Streifen zu 3000°K sorgen im Ambiente für komfortables und warmes Licht.*

## AREA COLECCIÓN

*Líneas limpias, geométricas, esenciales. Area es la máxima expresión de elegancia y linealidad. En color negro mate y aluminio. Cobertura satinada y tira de ledes con temperatura de color de 3000°K hacen cálido y acogedor el ambiente.*

## КОЛЛЕКЦИЯ AREA

*Лаконичные, геометрически четкие линии. Area – это высшее проявление элегантности и выразительности линий. Матового черного и алюминиевого цвета. Матированное покрытие и светодиодная лента 3000°K придают обстановке комфорт и тепло.*



AREA SUSPENSION

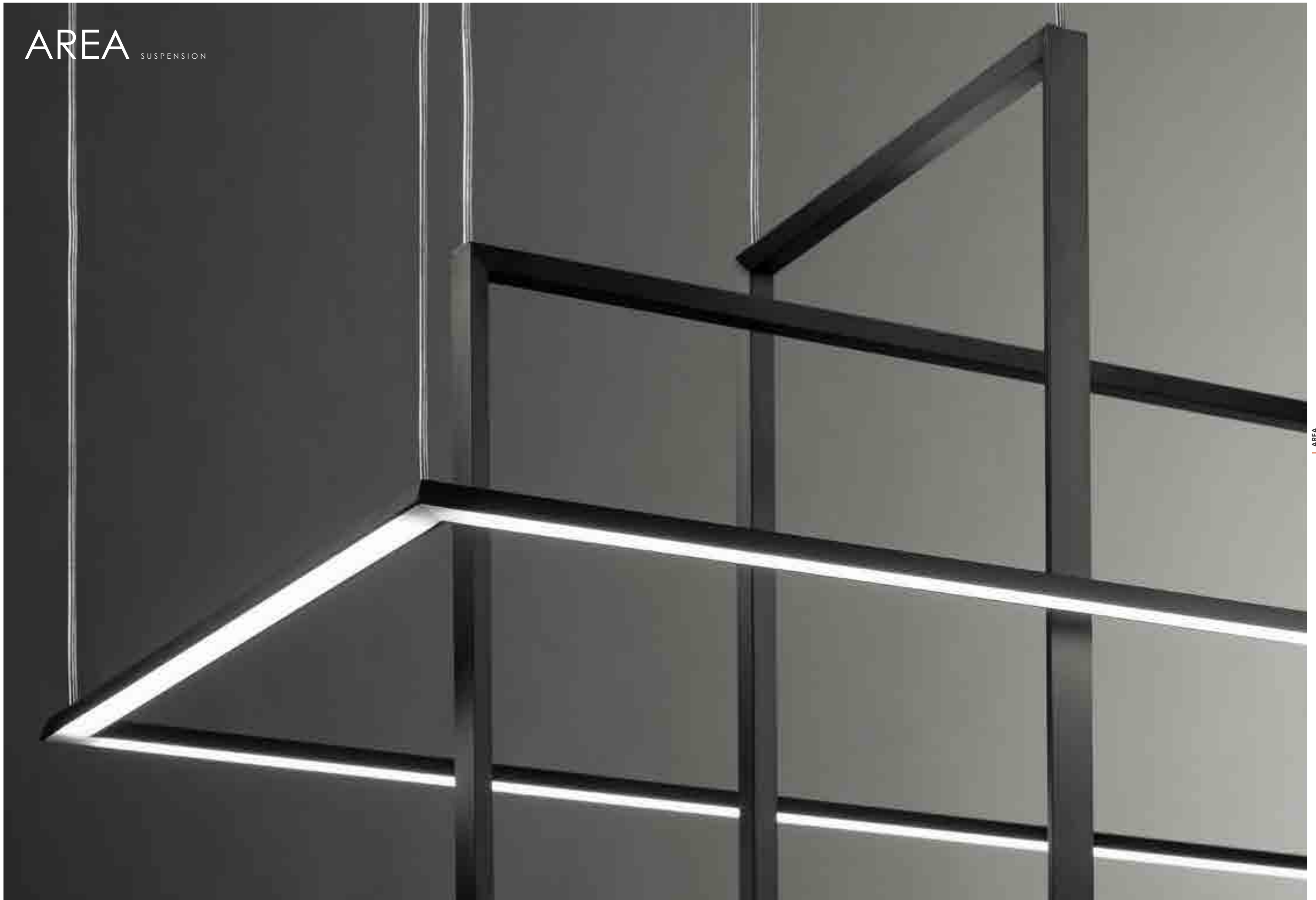

AREA



# AREA SUSPENSION



AREA



AREA SUSPENSION



AREA CEILING

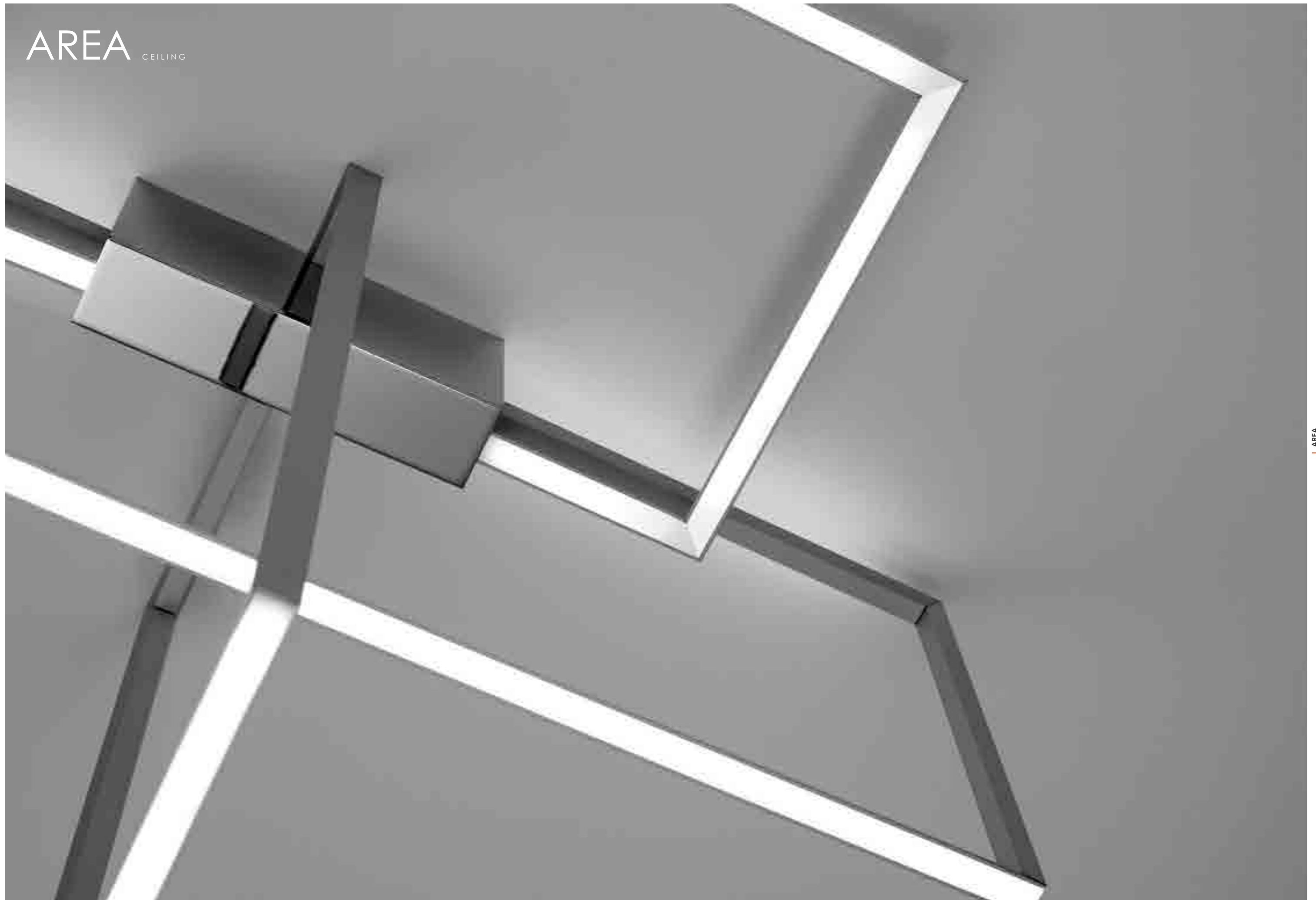

# AREA CEILING

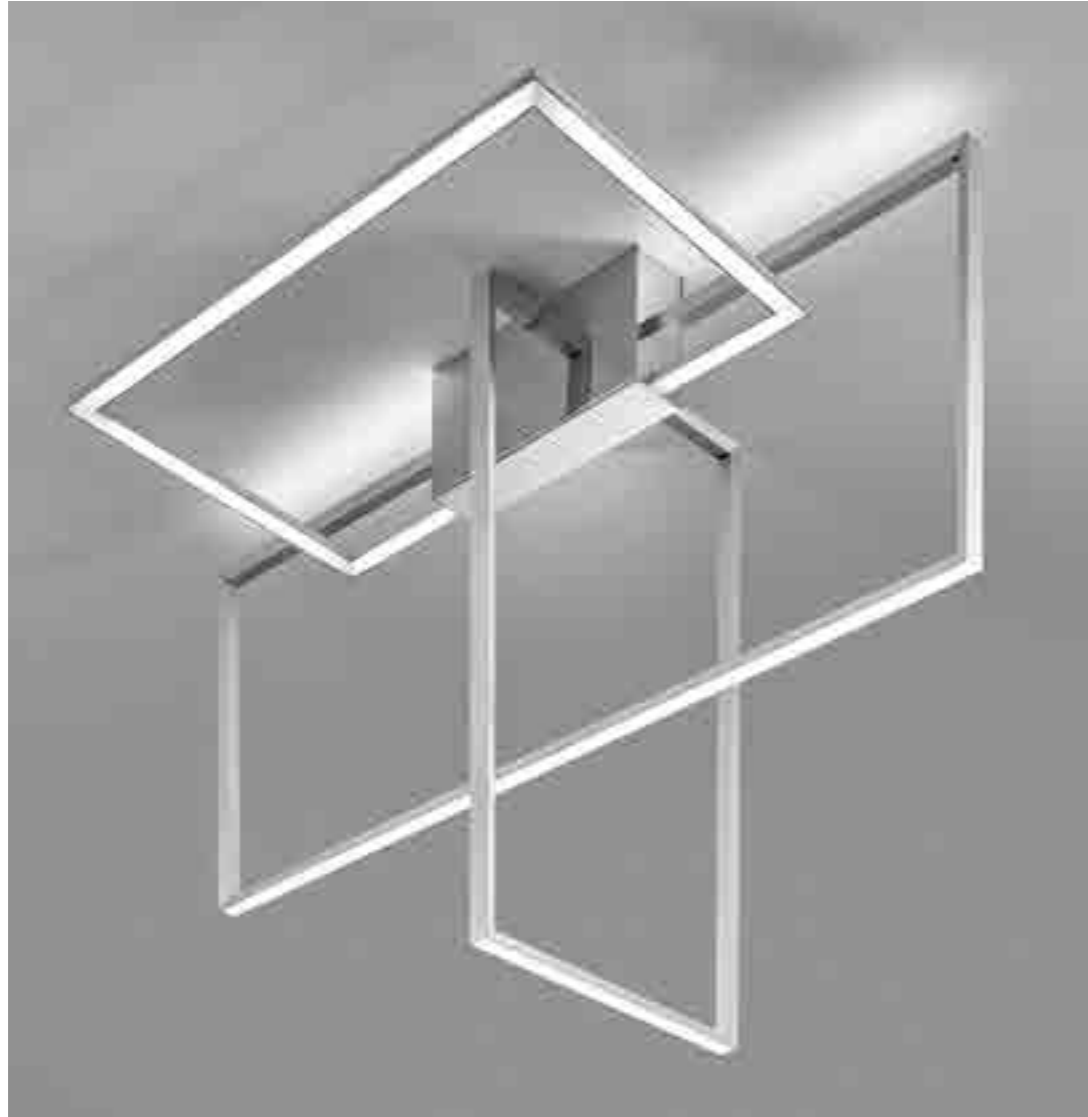



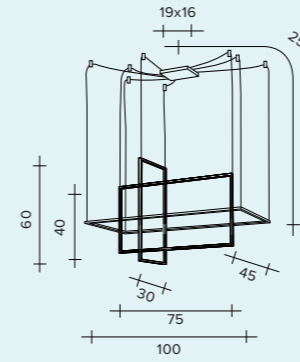

LED 60W - 12V  
3000°K  
450 ↑ Lumen  
4050 ↓ Lumen

### AREA Suspension

*Lampada a sospensione  
Pendelleuchte  
Lámpara colgante  
Подвесная лампа*



#### FINISHES / FINITURE / FARBE / ACABADOS / ОТДЕЛКИ

- Aluminium / Alluminio / Aluminium  
Aluminio / Алюминий
- Black / Nero / Schwarz  
Negro / Чёрный цвет

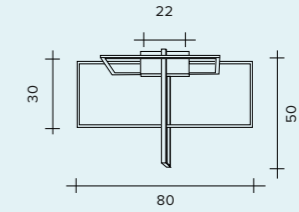

LED 42W - 12V  
3000°K  
315 ↑ Lumen  
2835 ↓ Lumen

### AREA Ceiling

*Lampada da soffitto  
Deckenleuchte  
Lámpara de techo  
Потолочная лампа*



#### FINISHES / FINITURE / FARBE / ACABADOS / ОТДЕЛКИ

- Aluminium / Alluminio / Aluminium  
Aluminio / Алюминий
- Black / Nero / Schwarz  
Negro / Чёрный цвет

# HONEY

## BLACK EDITION

design Sforzin Illuminazione

### HONEY BLACK EDITION

Three strong and decisive yet light and clear glass designs. Blown borosilicate glass, brushedchrome metal rose, power supply unit included. LED module: 5.3 W each, 424 lumen, 3000°K, 500 mA, non-dimmable.



### HONEY BLACK EDITION

Tre disegni di vetro forti, decisi ma leggeri e trasparenti. Vetro soffiato borosilicato, rosone in metallo nero, alimentatore incluso. Modulo led 5,3 w cad, 424 lumen, 3000°k, 500 mA non dimmerabile.

### HONEY BLACK EDITION

Drei starke und entschlossene, aber gleichzeitig auch leichte und transparente Glasdesigns. Geblasenes Borsilikatglas, Metallrosette in Schwarz, Netzteil eingeschlossen. LED-Modul jeweils 5,3 W, 424 Lumen, 3000°K, 500 mA nicht dimmerbar.

### HONEY BLACK EDITION

Tres diseños de vidrio fuertes, resueltos y al mismo tiempo ligeros y transparentes. Vidrio de borosilicato soplado, embellecedor de metal negro, fuente de alimentación incluida. Módulo led 5,3 w cada uno, 424 lumen, 3000°k, 500 mA de intensidad luminosa no regulable.

### HONEY BLACK EDITION

Три сильных, четких, но при этом легких и прозрачных дизайна стекла. Дутое боросиликатное стекло, потолочная чашка из черного металла, блок питания входит в комплектацию. Светодиодный модуль 5,3 Вт кажд., 424 люменов, 3000°K, 500 мА, не диммируемый.



HONEY SUSPENSION  
BLACK EDITION



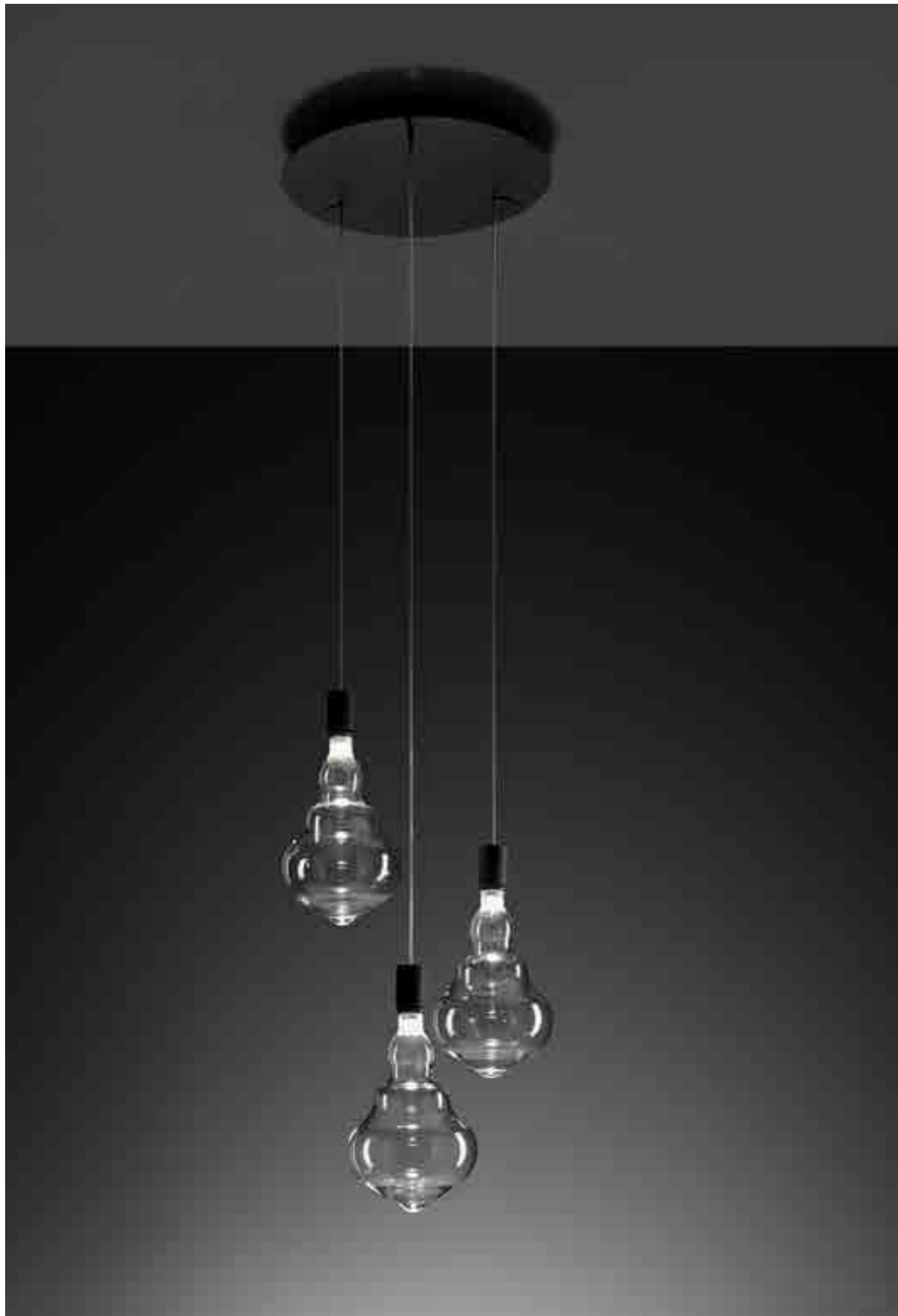

HONEY SUSPENSION  
BLACK EDITION



HONEY SUSPENSION  
BLACK EDITION





HONEY SUSPENSION  
BLACK EDITION



HONEY SUSPENSION  
BLACK EDITION







HONEY SUSPENSION  
BLACK EDITION



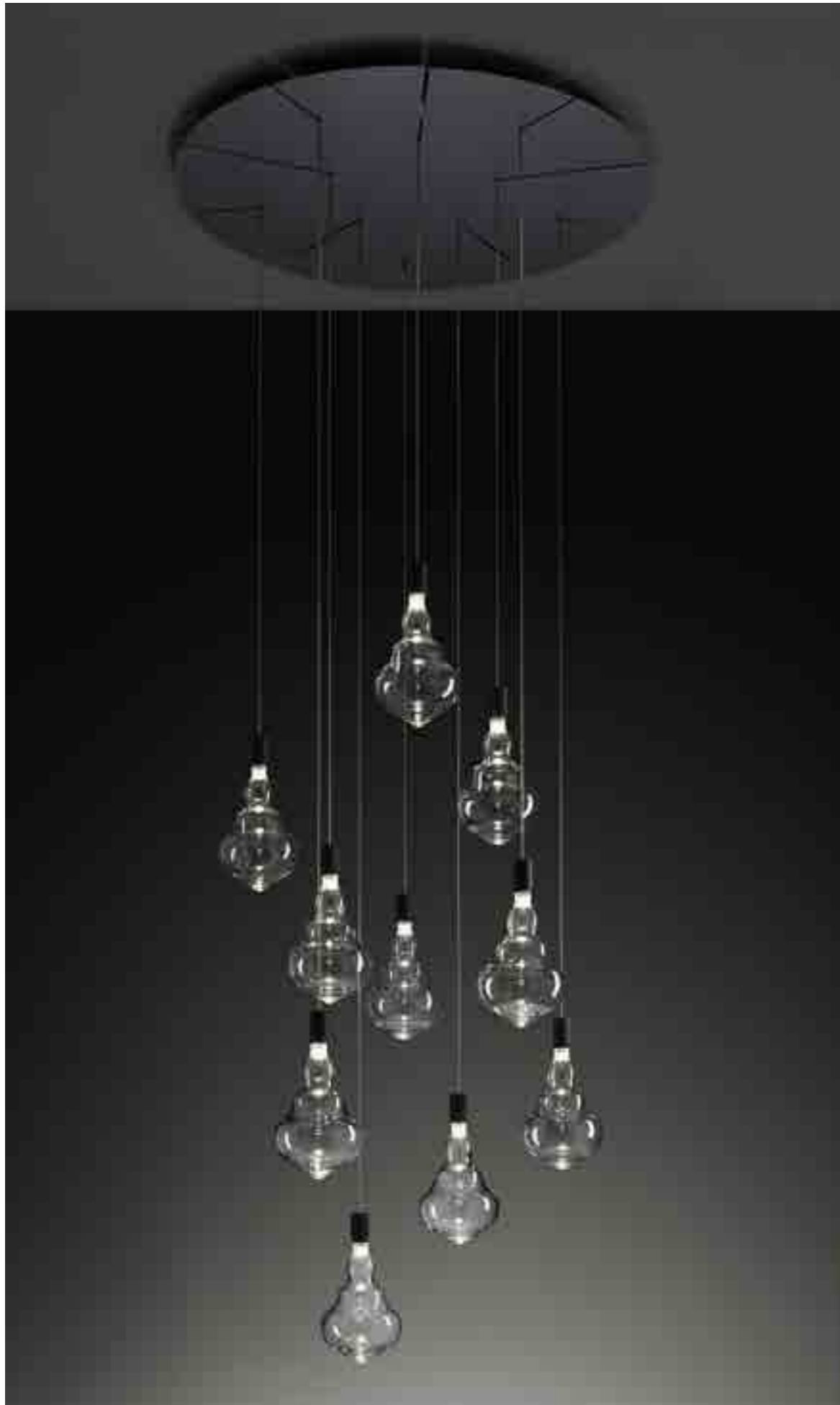

HONEY SUSPENSION  
BLACK EDITION



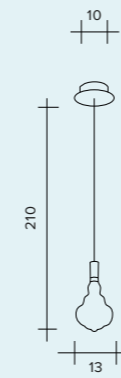

LED 5,3W - 500 mA  
3000°K / 424 lumen

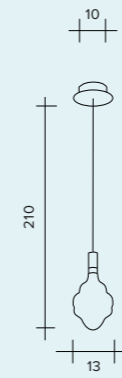

LED 5,3W - 500 mA  
3000°K / 424 lumen

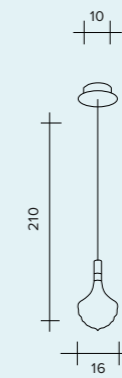

LED 5,3W - 500 mA  
3000°K / 424 lumen

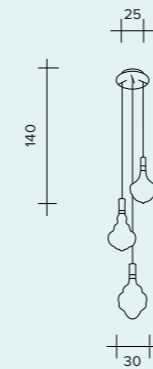

LED 15,9W - 500 mA  
3000°K / 1272 lumen

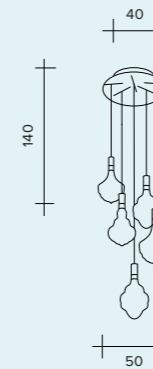

LED 31,8W - 500 mA  
3000°K / 2544 lumen

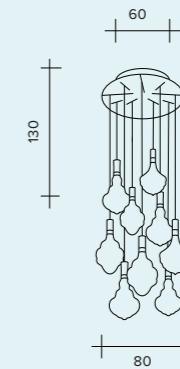

LED 47,7W - 500 mA  
3000°K / 3816 lumen

## HONEY BLACK EDITION Suspension

Lampada a sospensione  
Pendelleuchte  
Lámpara colgante  
Подвесная лампа



FINISHES / FINITURE / FARBE / ACABADOS / ОТДЕЛКИ

GLASS  
Vetri / Glas / Cristales / Стёкло

○ Trasparente / Transparent / Transparente / Прозрачный

# BEBA

design Marco Sforzin

## BEBA COLLECTION

Unique and decorative glass shades.  
Blown borosilicate glass in four colours:  
clear, chrome, bronze or gold.  
Fixture with white decentralisation kit  
or single drop roses with a white  
painted finish. G9 connection.



## BEBA COLLEZIONE

Vetri unici e decorativi.  
Vetro borosilicato soffiato in quattro  
colori: trasparente, croma, bronzo e oro.  
Montatura con kit di decentramento  
bianco o rosoni da una unica calata  
verniciati bianco. Attacco G9

## BEBA KOLLEKTION

Einzigartige und dekorative Gläser.  
Geblasenes Borsilikatglas in drei Farben:  
Transparent, Chrom, Bronze und Gold.  
Gestell mit Versetzungs-Set in Weiß  
oder Rosetten mit einfacher  
Hängelänge in Weiß. Anschluss G9.

## BEBA COLECCIÓN

Vidrios únicos y decorativos.  
Vidrio de borosilicato soplado  
en cuatro colores: transparente,  
cromo, bronce y oro.  
Montura con kit para descentrar  
blanco o embellecedores con una  
única bajada, pintados en color  
blanco. Casquillo G9.

## КОЛЛЕКЦИЯ ВЕВА

Уникальные декорированные  
стекла. Дутое боросиликатное  
стекло трех цветов: прозрачное,  
хром, бронза и золото. Оправас  
комплект для смещенного  
крепления белого цвета или  
с потолочными чашками,  
покрытыми белой краской,  
с одним выводом. Цоколь G9.

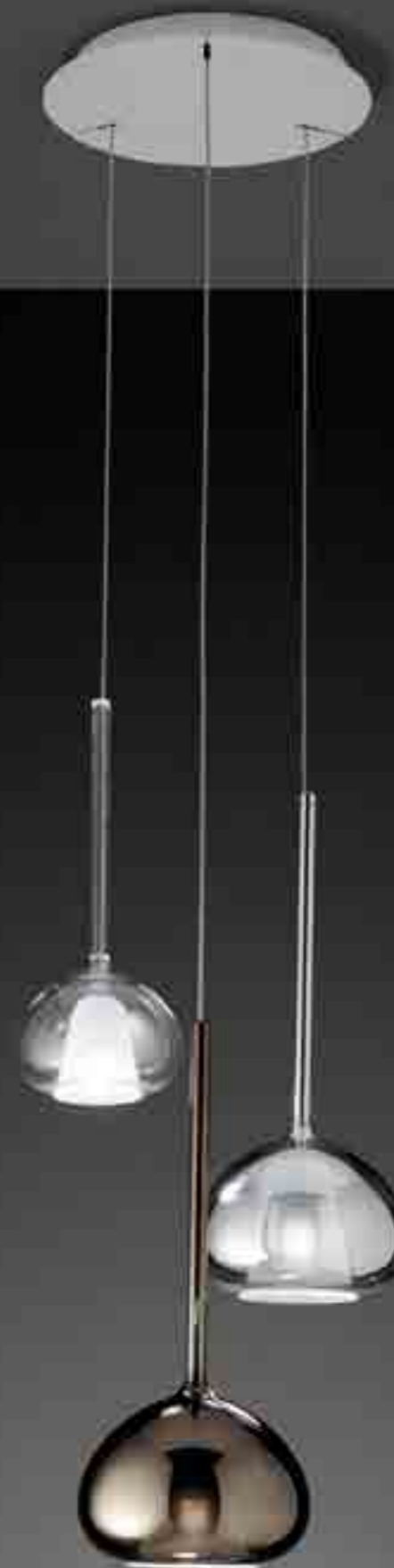

BEBA SUSPENSION



# BEBA SUSPENSION

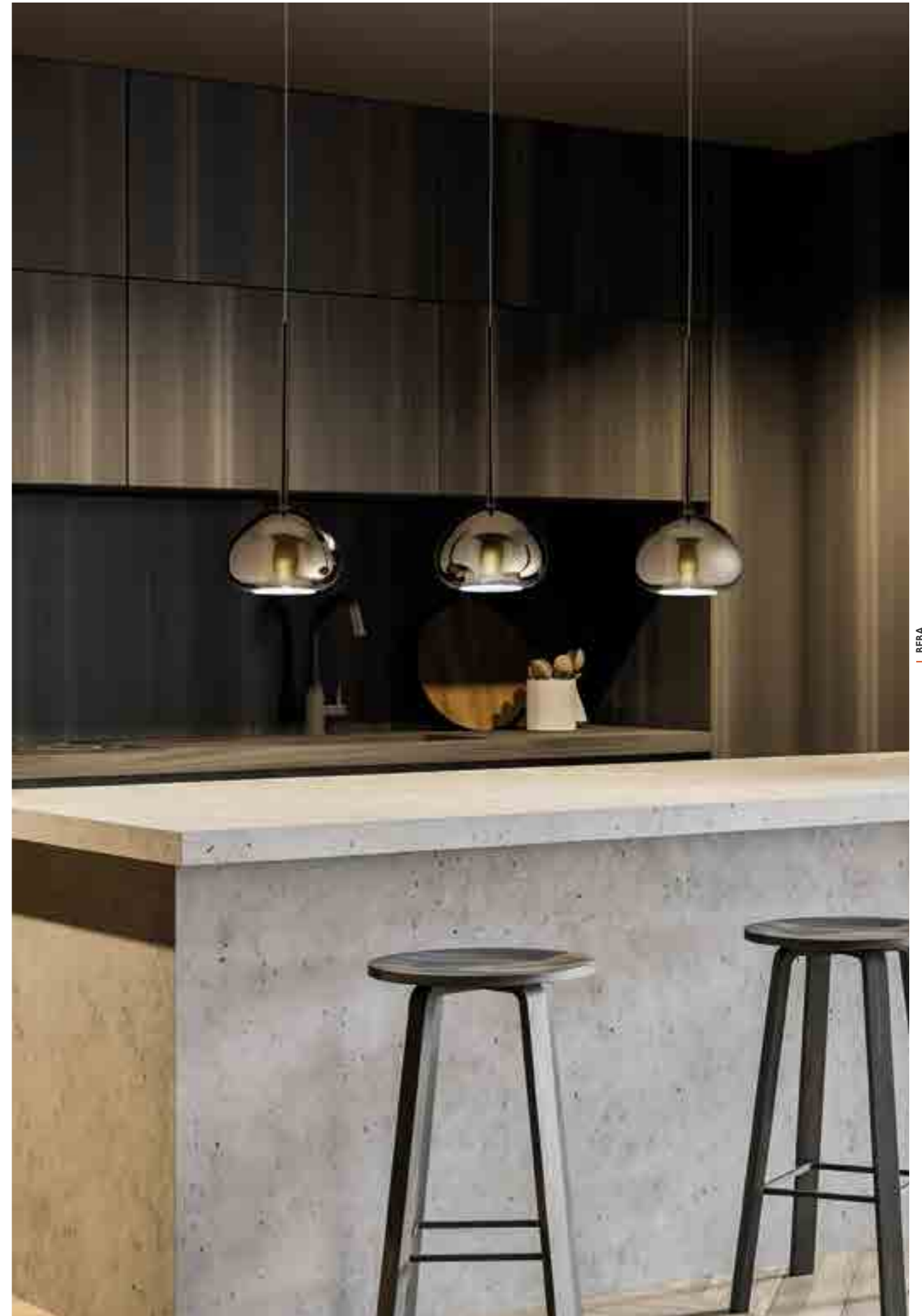



# BEBA SUSPENSION





# BEBA SUSPENSION





# BEBA SUSPENSION



BEBA SUSPENSION





# BEBA SUSPENSION



# BEBA SUSPENSION



# BEBA CANOPY

1730.M.30

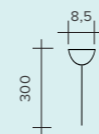

G9 1x max 28W - 230V

1730.M.40



1730.M.34

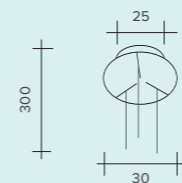

G9 3X max 28W - 230V

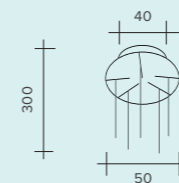

G9 5X max 28W - 230V

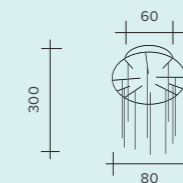

G9 10X max 28W - 230V

1730.M.41



1730.M.35

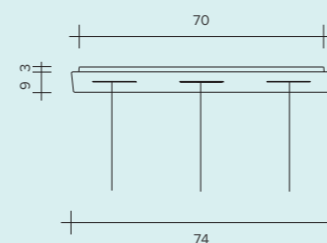

G9 3X max 28W - 230V

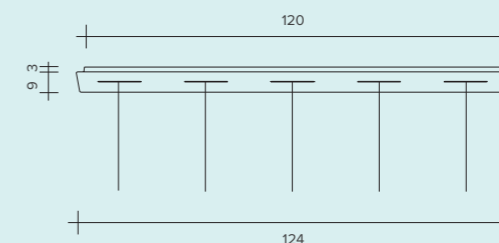

G9 5X max 28W - 230V

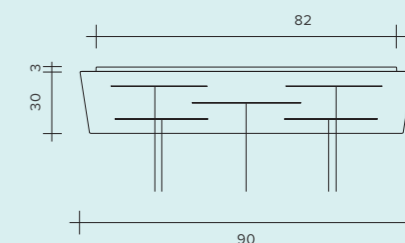

G9 5X max 28W - 230V

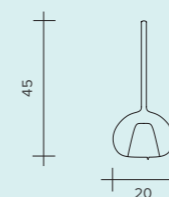
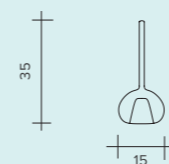

1730.M.42



1730.M.36



## BEBA Suspension

Lampada a sospensione  
Pendelleuchte  
Lámpara colgante  
Подвесная лампа



### FINISHES / FINITURE / FARBE / ACABADOS / ОТДЕЛКИ

#### GLASS Vetri / Glas / Cristales / Стёкло

- Trasparent / Trasparente / Transparent / Transparente / Прозрачный
- Chrome / Cromo / Chrom / Cromo / Хром
- Bronze / Bronzo / Bronze / Bronce / бронза
- Gold / Oro / Kupfe / Gold / Золото

#### CANOPY

##### Rosone / Baldachin / Florón / Основание светильника

- Embossed white / Bianco gofrato  
Weiß gaufriert / Blanco gofrado / Белый гофрированный

See codes and prices from page to page / Vedi codici e prezzi da pag. a pag. / Artikelnummern und Preise siehe Seite bis Seite  
Véanse códigos y precios desde pag. hasta pag. / См. коды и цены от страницы до страницы

308 - 309 - 310